

INSTRUCTION MANUAL

TOP+



Drying Oven (SL)

SLW 15, 32, 53, 115, 180, 240, 400, 750, 1000
SLN 15, 32, 53, 115, 180, 240

Pass-through sterilizer (SRWP)

SRWP 115, 240

Incubator (CL)

CLW 15, 32, 53, 115, 180, 240, 400, 750, 1000
CLN 15, 32, 53, 115, 180, 240

Cooled Incubator (IL)

ILW 53, 115, 240, 400, 750

Climatic Chamber (KK, KKS)

KK 115, 240, 350, 400, 500, 700, 750, 1200, 1450
KKS 115, 240, 400, 750

Thermostatic Cabinet (ST)

ST 1, ST 2, ST 3, ST 4, ST 5, ST 6, ST 500, ST 700,
ST 1200, ST 1450, ST 1/1, ST 1/1/1, ST 2/2, ST 2/3,
ST 2/4, ST 3/3

Laboratory Refrigerators (CHL)

CHL 1; CHL 2; CHL 3; CHL 4; CHL 5; CHL 6; CHL 500;
CHL 700; CHL 1200; CHL 1450; CHL 1/1; CHL 1/1/1;
CHL 2/2; CHL 2/3; CHL 2/4; CHL 3/3

Attention!
**Before using the equipment, please read carefully
this instruction manual!**



Manufacturer:
POL-EKO-APARATURA
Version 5.18
Date 14.03.2019

Contents

1	SCOPE OF DELIVERY FOR UNITS IN TOP+ VERSION	5
2	SAFETY PRECAUTIONS.....	7
3	APPLICATION OF THE UNIT	8
4	BEFORE THE FIRST USE	9
a.	Installation	9
4.2	Installation of container (in KK and KK FIT version).....	16
4.3	HEPA filter.....	16
4.4	To install internal glass door	17
4.5	Placement of the samples	17
4.6	Information on the stored samples.....	18
4.7	Connecting the unit to a PC or a network	18
5	GENERAL DESCRIPTION.....	19
5.1	Appearance of the devices SL/CL	19
5.2	Appearance of the device KK,IL	20
5.3	Appearance of the device ST/CHL	21
5.4	Programming capabilities	22
6	DEVICE OPERATION	24
6.1	Using the keyboard	24
6.2	Turning on the device	25
6.2.1	User log in	25
6.3	Main Screen	26
6.4	Menu Screen	27
6.5	Administrator Menu	27
6.5.1	Users	28
6.5.2	Events	28
6.5.3	Settings	28
6.5.4	Recorder.....	33
6.6	User Menu.....	33
6.6.1	Start.....	34
6.6.2	Programs.....	34
6.6.3	Recorder.....	36
6.6.4	Chart.....	37
6.6.5	Schedule of programs	37
6.7	Status Screen.....	39
6.8	7-day program mode	39
6.9	Defrosting function	40

6.10	Events identifier.....	40
7	OVER/UNDER TEMPERATURE PROTECTION	41
8	REMOTE CONTROL OF THE UNIT	41
9	TAKING CARE OF THE DEVICE IN CASE OF LONGER ABSENCE	42
10	MAINTENANCE	42
10.1	REPLACEMENT LAMPS	44
10.2	LED lighting.....	44
10.3	Optional UPS backup battery	44
11	TROUBLESHOOTING	45
11.1	Alarm Window	45
11.2	Alarm list	45
11.3	Troubleshooting.....	46
11.4	Software update	47
11.5	Declared runtime of humidifier components UCAN.....	47
12	WARRANTY	48
13	EXTERNAL REGISTRATION TEMPERATURE	48
14	RATING PLATE	49
15	ENVIRONMENTAL PROTECTION AND DISPOSAL OF THE UNIT	49
16	TECHNICAL DATA	50
	SL, CL, IL	50
	KK, KKS	52
	ST, CHL.....	55
	SRWP.....	58
17	WORKING SPACE WITH HUMIDITY	59
17.1	Without light	59
17.2	Devices in FIT version	59
18	MAINTENANCE AND INSPECTION REGISTER	60
18.1	Maintenance for ILW, CHL, ST, KKS or KK	60
18.2	Inspection.....	60

1 SCOPE OF DELIVERY FOR UNITS IN TOP+ VERSION

Table 1 Scope of delivery for CL laboratory incubator and SL drying oven in TOP+ version.

Unit	SL TOP+/CL TOP+								
Type	15	32	53	180	112	240	400	750	1000
Shelves [pcs.]	1	1	2	3	2	3	3	5	6
Slides [pcs.]	2	2	4	6	4	6	6	10	12
Power cord [pcs]	1	1	1	1	1	1	1	1	1
Rubber cap for access port [pcs.]	1	1	1	1	1	1	1	1	1
Key for lock [pcs.]	2	2	2	2	2	2	2	2	2
CD with TOP+ CONTROL software	1	1	1	1	1	1	1	1	1
Scriber [pcs.]	1	1	1	1	1	1	1	1	1
Ethernet cable [pcs.]	1	1	1	1	1	1	1	1	1
Wrench (13mm) for wheels adjustment (where applicable) [pcs.]	x	x	x	x	x	x	x	1	1
Calibration certificate [pcs.]	1	1	1	1	1	1	1	1	1

Table 2 Scope of delivery for ST cooled incubator and CHL refrigerators in TOP+ version

Unit	ST TOP+/CHL TOP+									
Type	1	2	3	4	5	6	500	700	1200	1450
Shelves [pcs.]	2	2	2	3	3	3	3	3	6	6
Slides [pcs.]	4	4	4	6	6	6	6	6	12	12
Shelves 'bottom', 'small' [pcs.]	x	1	1	1	1	1	x	x	x	x
Slides 'short' [pcs.]	x	2	2	2	2	2	x	x	x	x
Power cord [pcs.]	1	1	1	1	1	1	1	1	1	1
Rubber cap for access port [pcs.]	2	2	2	2	2	2	2	2	2	2
Key lock [pcs.]	2	2	2	2	2	2	2	2	2	2
CD with TOP+ CONTROL software [pcs.]	1	1	1	1	1	1	1	1	1	1
Scriber [pcs.]	1	1	1	1	1	1	1	1	1	1
Ethernet cable [pcs.]	1	1	1	1	1	1	1	1	1	1
Wrench (13mm) for wheels adjustment (where applicable) [pcs.]	x	x	x	x	x	x	x	x	1	1
Calibration certificate [pcs.]	1	1	1	1	1	1	1	1	1	1

Table 3 Scope of delivery for ILW cooled incubators in TOP+ version.

Unit	ILW TOP+ (FIT, FOT)				
Type	53	115	240	400	750
Shelves [pcs.]	2	2	3	3	5
Slides [pcs.]	4	4	6	6	10
Power cord [pcs]	1	1	1	1	1
Rubber cap for access port [pcs.]	1	1	1	1	1
Key for lock [pcs.]	2	2	2	2	2
CD with TOP+ CONTROL software	1	1	1	1	1
Scriber [pcs.]	1	1	1	1	1
Ethernet cable [pcs.]	1	1	1	1	1
Wrench (13mm) for wheels adjustment (where applicable) [pcs.]	x	x	x	x	1
Calibration certificate [pcs.]	1	1	1	1	1





Table 4 Scope of delivery for KK climatic chambers.

Unit Type	KK (FIT)								
	115	240	350	400	500	700	750	1200	1450
Shelves [pcs.]	2	3	3	3	3	3	5	2x3	2x3
Slides [pcs.]	4	6	6	6	6	6	10	12	12
Power cord [pcs]	1	1	1	1	1	1	1	1	1
Rubber cap for access port [pcs.]	2	2	2	2	2	2	2	2	2
Key for lock [pcs.]	2	2	2	2	2	2	2	2	2
CD with TOP+ CONTROL software [pcs.]	1	1	1	1	1	1	1	1	1
Scriber [pcs.]	1	1	1	1	1	1	1	1	1
Ethernet cable [pcs.]	1	1	1	1	1	1	1	1	1
Wrench (13mm) for wheels adjustment (where applicable) [pcs.]	x	1	1	1	1	1	1	1	1
Container for deionized water [pcs.]	1	1	1	1	1	1	1	2	2
Shelves under container[pcs.]	1	1	1	1	1	1	1	2	2
Container (cuvette) for waste water	1	1	1	1	1	1	1	1	1
Drain hose[pcs.]	1	1	1	1	1	1	1	1	1
Inlet hose[pcs.]	1	1	1	1	1	1	1	1	1
Calibration certificate [pcs.]	1	1	1	1	1	1	1	1	1

Table 5 Scope of delivery for KKS climatic chambers.

Unit Type	KKS			
	115	240	400	750
Shelves [pcs.]	2	3	3	5
Slides [pcs.]	4	6	6	10
Rubber cap for access port [pcs.]	2	2	2	2
Key for lock [pcs.]	2	2	2	2
CD with TOP+ CONTROL software [pcs.]	1	1	1	1
Scriber [pcs.]	1	1	1	1
Ethernet cable [pcs.]	1	1	1	1
Drainhose [pcs.]	1	1	1	1
Calibration certificate [pcs.]	1	1	1	1
Deionizer (reverse osmosis system)	1	1	1	1

2 SAFETY PRECAUTIONS

	<p>All warnings included in this instruction manual, especially these which appear next to the warning or informative symbols, should be obeyed at all times to ensure the safety of the user and to maintain the proper operation of the unit!</p> <p>The manufacturer does not take any responsibility for any damage which results from disobeying the instruction manual and misuse!</p>
	<p>For SL: When the device is working on 200°C or higher temperature, the housing and door can be hot.</p>
	<p>For units equipped with UV lamps: take necessary safety precautions. Do not expose your hands, skin and eyes to UV radiation as it may cause eyes diseases (conjunctivitis) or skin diseases (red spots or cancer). It is recommended not to open the unit while the UV lamps are on. The user should be equipped with protective gloves and glasses.</p>
	<p>This symbol indicates helpful tips.</p>

To guarantee your security and the longest efficiency of the unit, please comply with the following rules:

<p>1.</p>	<p><u>The unit cannot be installed:</u></p> <ul style="list-style-type: none"> • outside, • in damp places or places which can be easily flooded, • near flammable or volatile substances, • near acids or in corrosive environments.
<p>2.</p>	<p><u>It is forbidden to:</u></p> <ul style="list-style-type: none"> • store inflammable or volatile substances inside the unit, • touch live parts of the unit, • operate the unit with wet hands, • put water vessels on the unit, • climb or put any objects on the unit, • touch the compressor and condenser while the unit is connected to the mains.
<p>3.</p>	<p><u>You should:</u></p> <ul style="list-style-type: none"> • use only mains with earth to avoid electric shocks, • unplug the power cable holding the protective cover and not the cable itself, • disconnect the unit from the mains before undertaking any repairs or maintenance works, • protect the power cable and the plug from any damage and do not use the plug if it is improperly plugged in or if the cable is laid incorrectly, • disconnect the power plug before moving the unit, • disconnect the power plug if you are not going to use the unit for a longer period of time, • disconnect the unit and protect it from reconnecting if it has any visual faults.

We would like to inform you that we have taken all the necessary steps to make sure that the unit will meet your requirements and will work reliably. Due to the fact that we constantly improve our products and extend their range, we invite you to provide us with any feedback. All opinions are welcome! Visit us at: www.polekolab.com

3 APPLICATION OF THE UNIT

Drying ovens (SL), Incubators (CL), cooled incubators (IL), climate chambers (KK, KKS), cooled incubators (ST), laboratory refrigerators (CHL) was designed to store and test safe and non-hazardous solid and liquid materials at constant temperature. Units can be operated under laboratory and Industrial conditions according to the requirements of this manual.

TOP+ models were equipped with PID microprocessor temperature controller with a large (5,7") full colour touch screen, intuitive menu and user friendly software. Parameter preview and unit control is possible via touch panel or remotely using Ethernet and the TOP+ Control computer program.

The performance of the internal chamber and the housing material depend on the ordered device version. As standard, in TOP+ version internal chamber is made of stainless steel, DIN 1.4301 and housing is made of powder-coated sheet. Each unit is equipped with a key lock.

Climatic chamber (KK) is equipped with ultrasonic humidifier which is suitable for applications requiring temperatures up to 60°C. The ultrasonic humidifier acts on the principle of breaking water using ultrasound to fine steam molecules.

Climate chamber (KKS) has been equipped with a steam humidifier. The WA steam humidifier (steam generator) is a closed boiler that produces steam with higher pressure than atmospheric. The heat required to produce steam is obtained by a heater placed in a boiler. Much higher temperature and humidity range is used in more applications in comparison to KK units.

The photoperiodic (FOT – available in STD units) and phytotron (FIT) functions allow you to perform day and night simulations. FIT version compared to the FOT version also allows smooth adjustment of light intensity. Fluorescent lamps can be mounted in walls, doors and over shelf panels. LED panels of the specified colour are also available on request.

Detailed description of all options and accessories are available in POL-EKO-APARATURA sp.j. catalogue.

4 BEFORE THE FIRST USE

By default, the unit is sent in a cardboard box. It is necessary to transport it in the upright position and prevent it from any unintended movements.

On the surface of unit components made of stainless steel, light discoloration may occur. It is a result of the technologies used in the production of metal sheet in accordance with the requirements of PN-EN10088-2 standard and it is not a defect of the unit.

	Once you receive the unit, please check its the technical condition and all accessories. Any claims regarding latent defects should be reported to the manufacturer, while any damage during transport or incomplete accessories need to be passed to the entities who are responsible for the transport and unloading.
--	---

	Only for KK, KKS, ILW, ST, CHL: While carrying the unit, please do not tilt it to one side more than 45° from the upright position, as there is a high probability of the damaging the compressor. If it is necessary to tilt it to one side more than 45°, then after placing it, please wait at least 2 hours before connecting the unit to the mains.
--	--

a. Installation

Installation place:

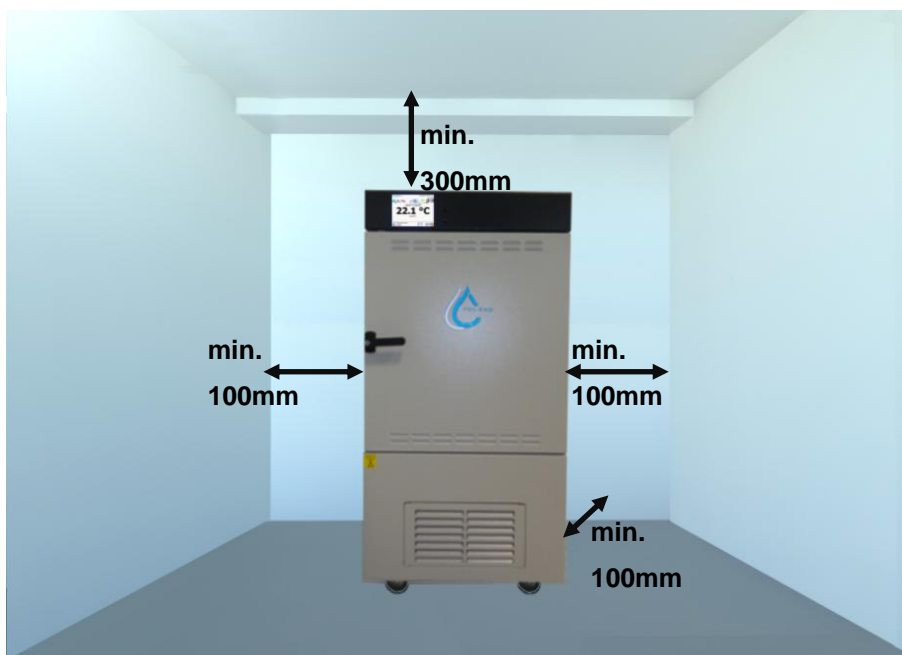

The unit should be placed at a minimum distance of 100mm from the wall of the room. The height of the room must be higher than the height of the unit by min 300mm.

In drying ovens (SL) and in incubators (CL) on the back of the unit, there is an air-flap located, through which the hot air is extracted. The manufacturer recommends using a non-flammable insulation screen on the wall or increasing the distance from the wall. Failure to do so may result in permanent damage to the wall and in extreme cases, to a fire.

Additionally the place of installation of the unit should meet the following conditions:

- Ambient temperature +10°C...+26°C *
- Low relative humidity of the ambient air to 60% *
- The unit has not been designed to work in highly dusty environments
- Provide adequate ventilation in the room
- The unit should be put on a hard and stable substrate
- This unit may not be exposed to direct sunlight
- The unit should be kept away from any heat sources *
- The unit is not designed to be built-in
- The place of installation of the unit should contain a mains socket 230V/50Hz or 400V/50Hz (SLW/SRWP 400/750/1450 and all models KKS),
- For KKS ¾" connection of water inlet
- For KK, KKS draining water to the sewage system.

*) If it is not possible to locate the unit in a place that fully complies with the above requirements, make sure that the following points are obeyed:

- if the room temperature is higher than recommended, monitor the temperature in the chamber using an additional independent temperature sensor; if the room temperature is equal or higher than 45°C, the compressor will not start working. It will not be possible to cool the chamber.
- if the room temperature is lower than recommended, under no circumstances should you turn the cooling system on, as this may damage the compressor; At room temperatures between 0° to 10°C it is only possible to heat up the chambers.
- in highly humid environments, control the frosting of evaporator and walls more often than recommended. If necessary, perform the defrosting operation.

The waste water is discharged by gravity. The drain hose cannot be higher at any point than the drain outlet, otherwise, this may cause leakage from the bottom of chamber and may damage the humidifier.

If you don't comply with the recommendations of place of installation, you may lose your warranty rights.

If you don't comply with the above recommendations, it may deteriorate the following technical parameters:

- temperature stability
- temperature homogeneity
- power consumption
- frosting of evaporator



Sudden temperature changes related to e.g. opening of the door does not pose a threat to stored products(vaccines in particular)- the temperature variation is short-lived

The electric installation should meet the following conditions:



Connect device to a socket with ground. The power specifications are listed in the technical data section and on the rating plate of the unit

The electric installation should be secured by a 16 A antisurge fuse. It is recommended that the installation is equipped with a residual current circuit breaker.

The plumbing should meet the following conditions (for KK and KK FIT):

- required water pressure: 0,1 – 6 bar,
- required demineralized water,
- water temperature between 5 - 40°C,
- no organic pollution,
- the plumbing can be open (drain) or closed.



The KK unit is equipped with an ultrasonic humidifier. Using the demineralized water reduces the risk of emerging unwanted salts and extends the life of the humidifier.

It is recommended that you use water according to PN-EN ISO 3696:1999 norm (minimum level 2 purity type):

- **conductivity at 25°C: not more than 1 µS/cm**

It is allowed to use water of purity level 3 to PN-EN ISO 3696:1999, but a white sediment may be formed on the chamber walls as a result.

The device is equipped with a demineralized water tank. Water in the tank is necessary for proper functioning in the absence of connection to the installation. The installation of the tank is described in the chapter 'Installation of container (in KK and KK FIT version)'. Before first use, check that the water inlet valve is open.



KK and KK FIT: Before using demineralized water tank, the water fill cap should be unscrewed to prevent from under pressure in the tank.

Water and sewage system for KKS units with steam humidifier (steam generator) should meet following conditions:

- Water pressure in installation – 0,1-6 bar,
- The humidifier is supplied with demineralized water,
- Water temperature between +5 - 40°C,
- Lack of organic pollutants,
- The plumbing can be open (drain) or closed.

KKS devices are equipped with a pump.

Pump specifications:

- Max. vertical pumping- 4,5[m],
- Max. pumping distance- 50[m] (slope min.1%),
- Max. flow rate - 342[l/h],
- Tank volume 2,1l.

Reverse osmosis system (concerns KKS units)

The reverse osmosis system is the best and most effective method of water purification. The reverse osmosis combined with the sediment and active filter system gives water free from organic and non-organic pollutants up to 99%.

Parameters that must be met for water to be returned to the reverse osmosis system:

- pressure: 3-6 bar,
- working temperature $+2 \div +45^{\circ}\text{C}$,
- pH of water 2-11,
- maximum salinity of water 2000ppm (mg/l),
- maximum water hardness 400ppm,
- maximum alkalinity 8mval/l,
- maximum iron and manganese content 0,05ppm.

Consumables of reverse osmosis system

Component	Operating time(months)	Symbol
Mechanical insert I	6	FCPS20
Carbon cartridge	6	FCCBL
Mechanical insert II	6	FCPS5
Linear cartridge	12	AIMRO
Tank	48	AIMRO
Osmotic membrane	48	TFC-75 GPD Aquafilter

Frequency of replacement of consumable elements depends on number of factors but above all on water quality. For water with significant contamination, the operating life of all consumables should be shortened. Operating materials are not subject to warranty replacement.

The equipment of the reverse osmosis system consists of:

- hose $\varnothing 6$ 2m long, 3pcs.
- hose $\varnothing 12$ 0,3m long, 1 pc.
- osmosis solenoid power cord 1pc.
- water supply connector: 3/4" external thread x 1/4" internal thread (with ball valve on the hose 6mm) x 3/4" internal thread, 1pc.

Reverse osmosis system installation scheme (only for KKS):

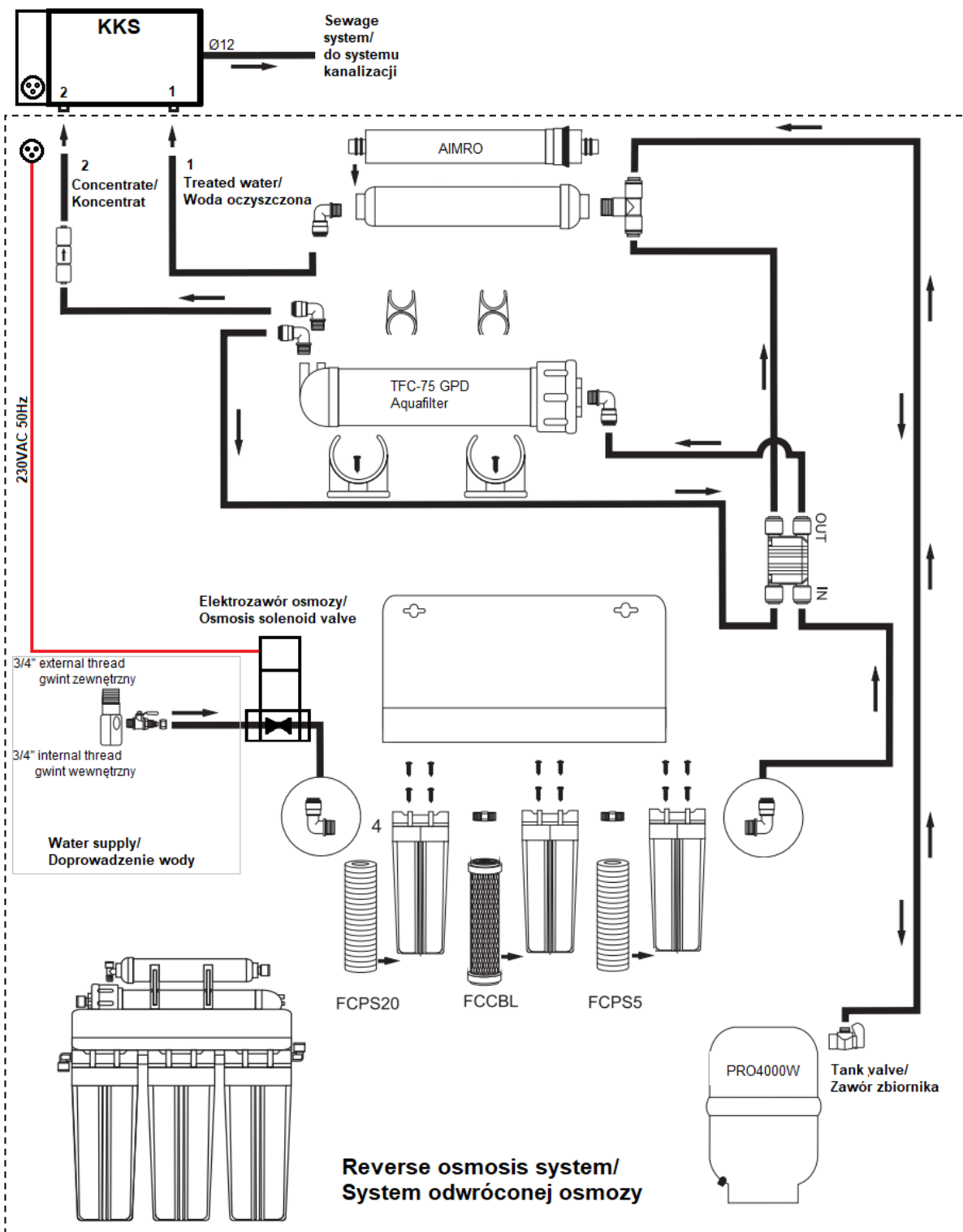

Switch on of reverse osmosis system and KKS unit:

1. Connect the power supply to the solenoid valve 230VAC to the socket on the KKS unit
2. Switch on the KKS power plug to the power socket and push the main switch
3. Connect hose Ø12 to drain out of the KKS chamber and into the sewage system
4. Connect hoses Ø6 as indicated on the reverse osmosis system and on the KKS unit (1 to 1, 2 to 2),
5. Connect hose Ø6 to the water ball valve and the osmosis solenoid valve
6. Unscrew the tank valve
7. Unscrew the water ball valve for water supply



During rinsing of the steam humidifier, the temperature of the water used can temporarily reach the temperature 80°C.



Cyclically, every 24 hours there is a partial drain of water from the humidifier, accompanied by bubbling and murmuring.



At least 2 times a year, full rinsing of the humidifier should be carried out. Reminder of this duty is displayed in the display window. During the full rinsing of the humidifier there is a temporary drop in humidity in the chamber and an increase in the noise level of the unit. The manufacturer recommends performing this task beyond of carrying of tests.

Failure to fully rinse the humidifier will void the warranty. The method of execution is described in section 6.5.3, Other tab.



In case of:

- power outages
- switch off the device using the main switch,
- connect the device from a power source,
- longer pause

the water ball valve must be turned off to supply water from the water mains.

Failure to do so may result in the product being flooded and rooms.

Castors



After placing the unit, please secure it by blocking the wheels (if they are provided along with it).

The unit can be equipped with leveling castors. After the unit has been placed in its destination, lock the castors and level the unit using the red screw located inside the castor's casing. You can adjust the level using fingers or a flat wrench size 13.

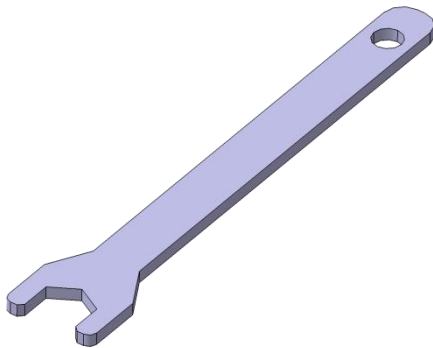

Wheels with capability of leveling are only for positioning the device at the destination place. They cannot be used to transport the device!

If the unit, table or base is fitted with lockable castors, the wheels must be locked when the device is placed in proper position.



4.2 Installation of container (in KK and KK FIT version)

ATTENTION: doesn't concern KKS units.

The unit is equipped with a distilled water vessel. This is necessary for the unit's proper operation in case of no connection to the water supply system.

Install the shelf of the container on the back of the chamber. For installation is required Philips screwdriver PZ2.

To mount the base:

- Use 2 provided screws. Screw them in such a way that there is 3mm space between the wall and the top of the screw.
- Install the base and screw the top screws to the end and the 2 remaining screws in the lower part.

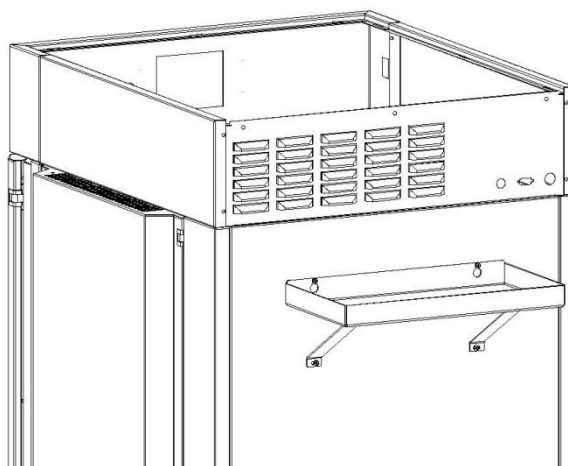

4.3 HEPA filter

The HEPA filter is an optional accessory for the CL/SL range. This option is factory preinstalled. The filter has H13 class to PN-EN1822-1:2009 norm. It should be located at the rear of the unit. The filter itself is delivered separately. You should place it in the cover so the black gasket is outside, then screw the cover to the rear wall of the unit. Please ensure that the distance between the filter and wall is not less than 100mm.



4.4 To install internal glass door

Internal glass door are available as an option in CHL and ST units and not available in ZL and SL units. In IL, CL, KK and KKS units internal glass door are standard equipment

The internal glass door comes as an option. To open or close the door use the plastic latch so the door will not fall out of the hinges. If the unit is working at high temperatures, do not touch the inner chamber or the glass door to avoid burning your skin. Use protective gloves to protect yourself.



	<p>The manufacturer does not recommend to install and disassemble of internal glass doors. Incorrect assembly or dismantling may damage the glass and cause injury to the user.</p>
---	---

4.5 Placement of the samples

To provide proper air circulation and stable conditions in which the samples are stored in the chamber, it is necessary to keep the following rules:

- the max height of the samples should not exceed 1/3 of the space below the shelves
- the samples should be placed in such a way that so that the horizontal surface between the containers does not exceed 1/3 of the width and height of the empty shelf
- the space between the samples and between the samples and the wall should be more or less equal

The picture below is an example of the placement of samples in the chamber:

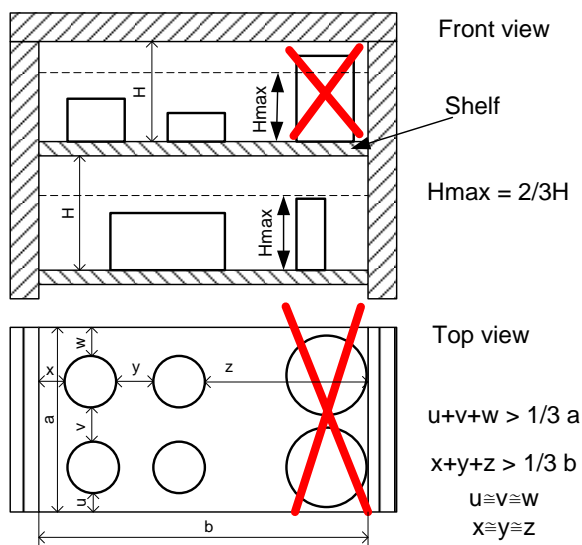

Following the above rules will provide best temperature and humidity (for KK, KKS range) stability.

4.6 Information on the stored samples

Water may gather on the bottom of the chamber. It is a result of condensation of the water vapour located in air if the set temperature is considerably lower than the ambient temperature.

The amount of water depends on the following factors:

- Differences between ambient and set temperatures
- Number and frequency of door openings
- Temperature of samples



If water gathers, use a dry cloth to wipe the bottom of the chamber.

Do not use any cardboard boxes, sponges and other hygroscopic materials for storing the samples since they may increase the relative humidity in the chamber.



Too high relative humidity in the chamber may frost the refrigerant and lower the performance of the cooling system. It may lead to higher energy consumption.



(For KK devices) Draining off of water is done by water outflow in accordance with gravitation. For this reason there might be little water left on the bottom of the chamber.

4.7 Connecting the unit to a PC or a network

A TOP+ unit can be controlled with the *TOP+ control* program manufactured by POL-EKO-APARATURA. It's required to connect the unit to an existing LAN network, or to a PC, which the software is installed on, using a 100Base-TX Ethernet cable, known as a *twisted-pair cable*. The default IP address of the unit is **192.168.1.210**.

If you connect the unit to a LAN network, use an inverted network cable and set the correct IP address, subnet mask and ports in the control panel of the unit.

If you connect the unit to a PC network card directly, the IP address of the PC should be in the range 192.168.1.1 – 192.168.1.209, so it is within the same subnet like the unit.

5 GENERAL DESCRIPTION

5.1 Appearance of the devices SL/CL

Below is a photo of a CL53 device with a capacity of 56l with a description of essential components of the device.

Front view

- 1) Rating plate
- 2) Access port Ø30mm for external sensor
- 3) Internal glass door
- 4) Adjustable feet
- 5) Door sensor
- 6) Touch screen
- 7) Stylus
- 8) USB port
- 9) Shelf
- 10) Handle with lock
- 11) External solid door

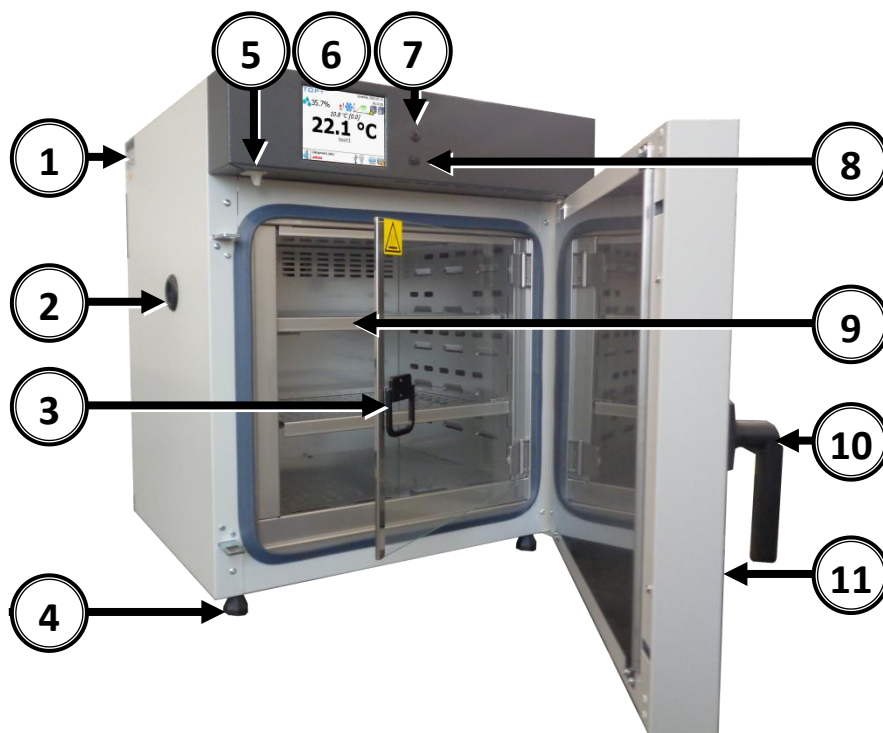

Rearview

- 12) Power socket C20
- 13) Main switch
- 14) Power cord
- 15) Fuse
- 16) Electronics cooling fan
- 17) RS232 socket
- 18) LAN socket
- 19) Air-flap

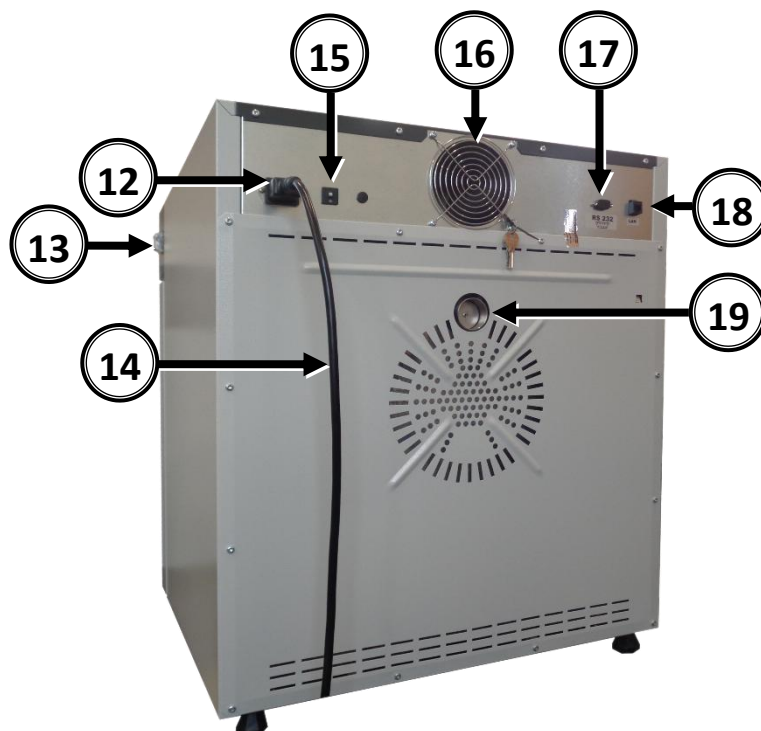

SRWP has doors on both sides of the device

5.2 Appearance of the device KK,IL

Below is a photo of **KK115 - capacity 115l** with a description of the essential components of the device.

Front view

- 1) Rating plate
- 2) Access port Ø30mm for external sensor
- 3) Temperature sensors
- 4) Shelf
- 5) Condenser cover
- 6) Wheels with break
- 7) Door sensor
- 8) Touch screen
- 9) Stylus
- 10) External solid door
- 11) USB port
- 12) Chamber fan
- 13) Handle with lock
- 14) Internal glass door
- 15) Illumination FIT (option)

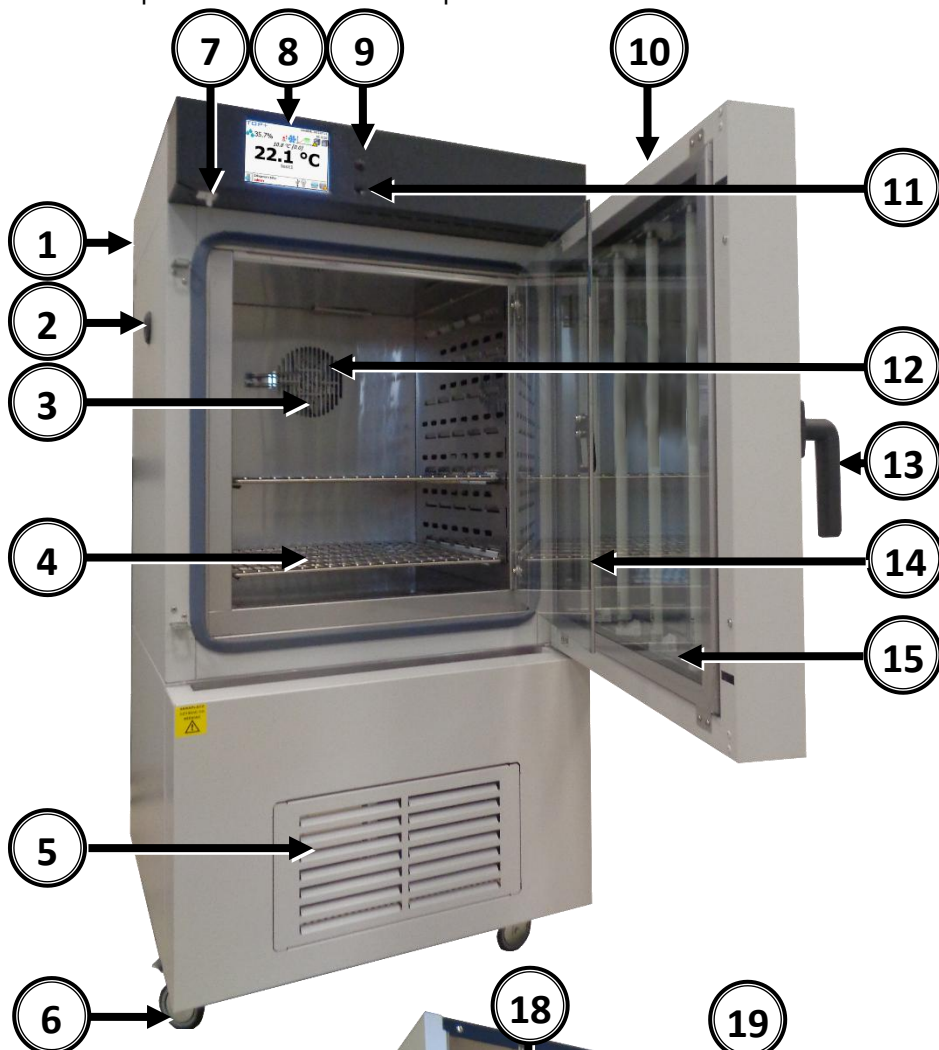

Rearview

- 16) Main switch
- 17) Power cord
- 18) Fuse
- 19) LAN socket
- 20) RS232 socket
- 21) Water inlet (for KK)
- 22) Water outlet (for KK)

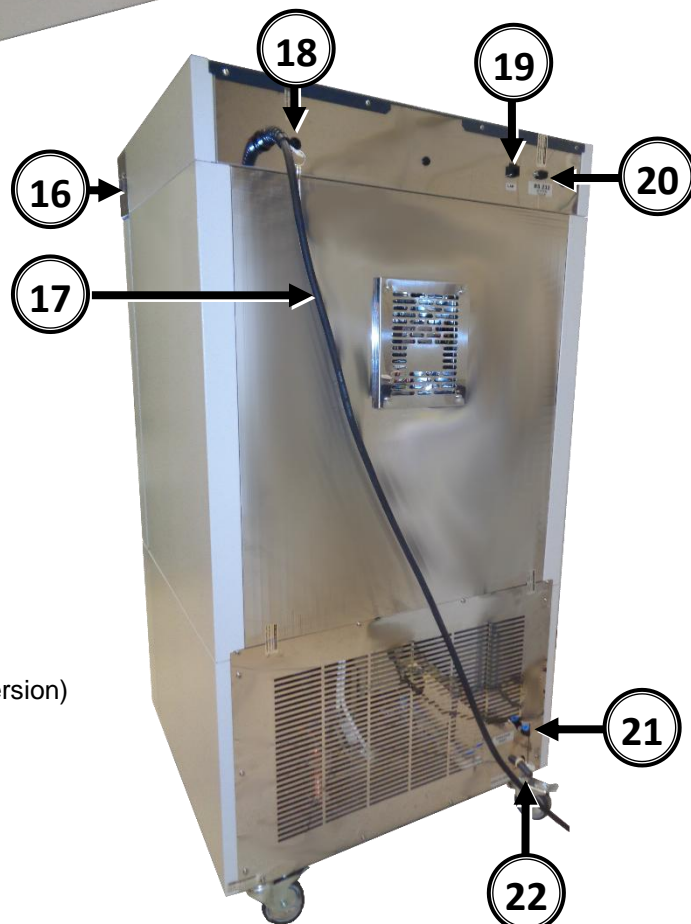

A water tank should also be installed

(see chapter: 4.2 Installation of container - (in KK and KK FIT version)

In KKS unit, on the back there is a cover of water

tanks, drain is located in the middle.

5.3 Appearance of the device ST/CHL

Below is a photo of ST 3 – capacity 200l unit with optional external glass door (A version) with a description of the essential components.

Front view

- 1) RS232 socket
- 2) Rating plate
- 3) Access port Ø30mm for external sensor
- 4) Adjustable feet
- 5) LAN sockets
- 6) Temperature sensor
- 7) Touch screen
- 8) Stylus
- 9) USB port
- 10) Key lock
- 11) Door sensor
- 12) Internal LEDlight
- 13) Fan chamber
- 14) Shelf
- 15) External Glass door (option)

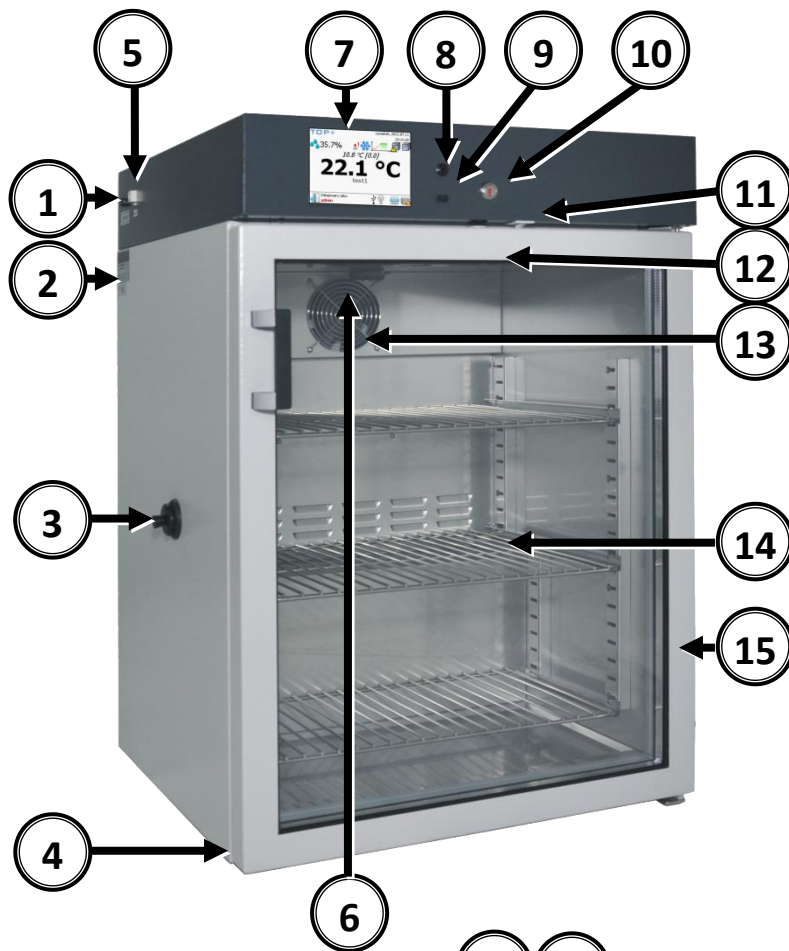

Rearview

- 16) Main switch
- 17) Condenser
- 18) Fuse
- 19) Power socket C14
- 20) Power cord
- 21) Cooling system

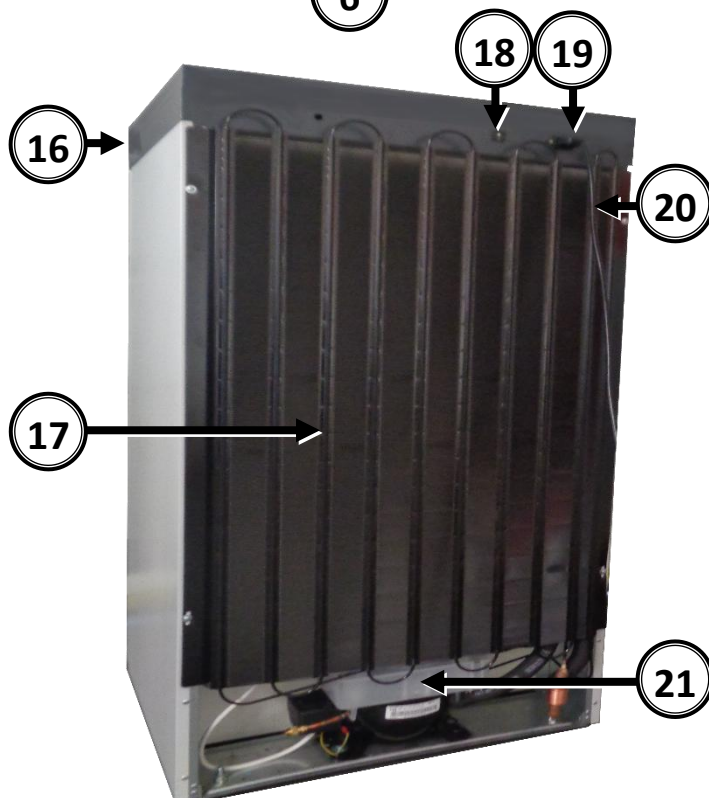

5.4 Programming capabilities

Five different User accounts can be defined with the device. Additionally there is one Administrator account to control the device's system.

The Administrator can distribute 20 programs among the Users, defining the maximum number of programs available for each User.

There are four different types of programming available:

Simple parameter

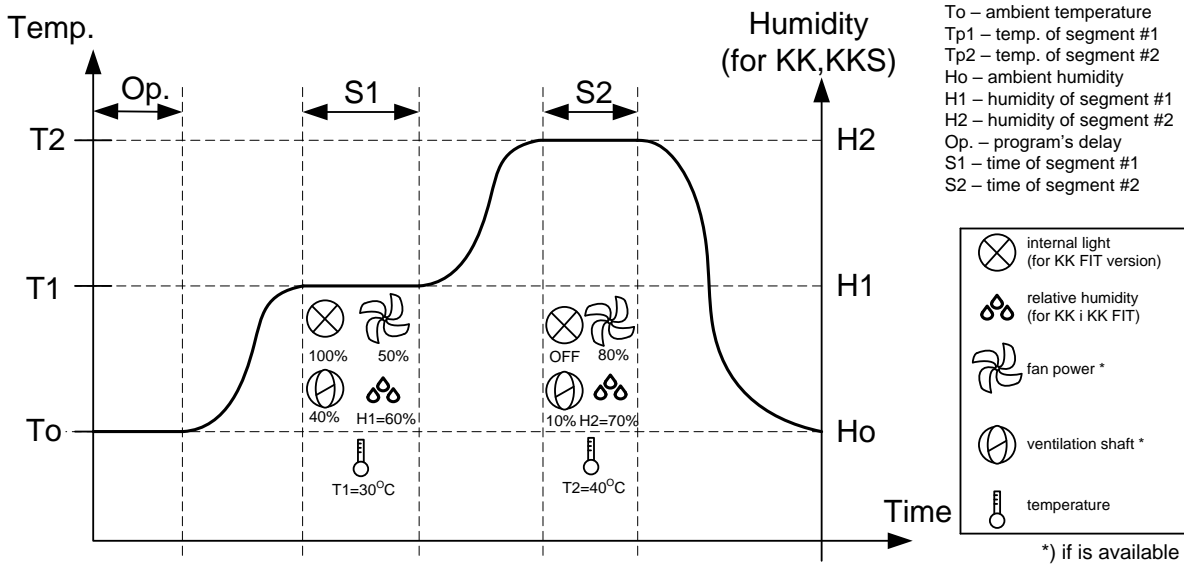

Simple time – time is a priority

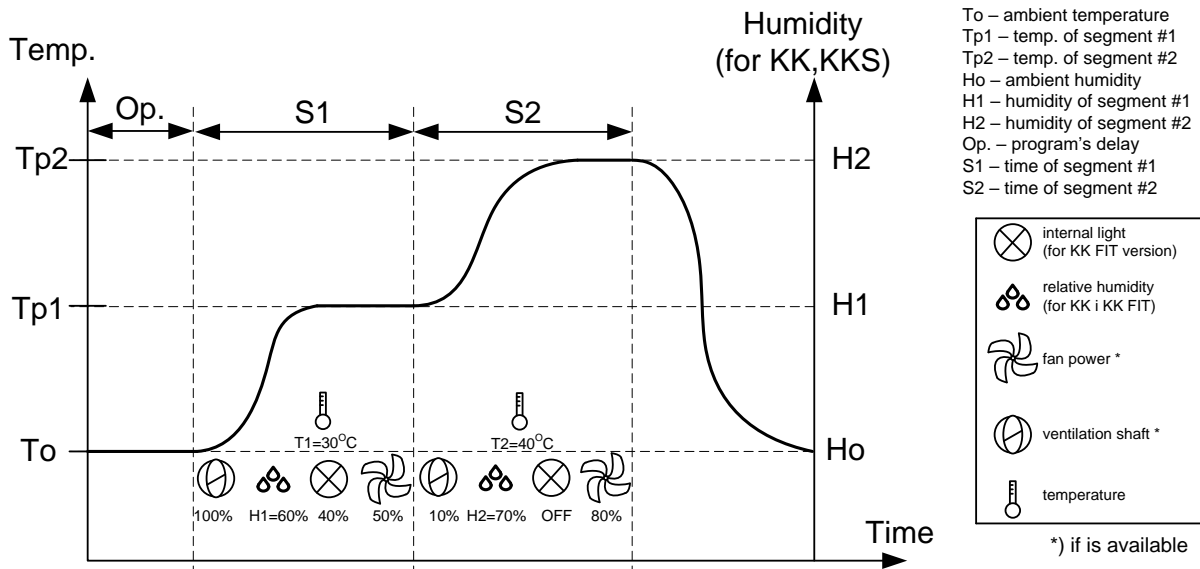

Simple parameter program – the program will start counting segment time when the set temperature (or temperature and humidity for KK, KKS) has been achieved.

Simple time program – allows to determine segment time and set temp achieving time.

Simple type defines the temperature and duration time of a maximum of 9 segments. The achieving times between segments cannot be defined. Moreover, for each segment it is possible to define the operation of the chamber fan and opening of the air flap (ventilation shaft) – if the unit is equipped with them.

 The level of fan speed and air flap opening while achieving set temp equal the parameters of the next segment. In the above example, the fan speed between segment S1 and S2 while achieving the set temperature will work at 80% speed. In the simple mode, the achieving time depends on the temperature differences between each segment.
For Climatic Chambers KKS KK and KK FIT while achieving the set temperature, the controller tries to achieve the humidity set in the next segment.

Advancedparameter

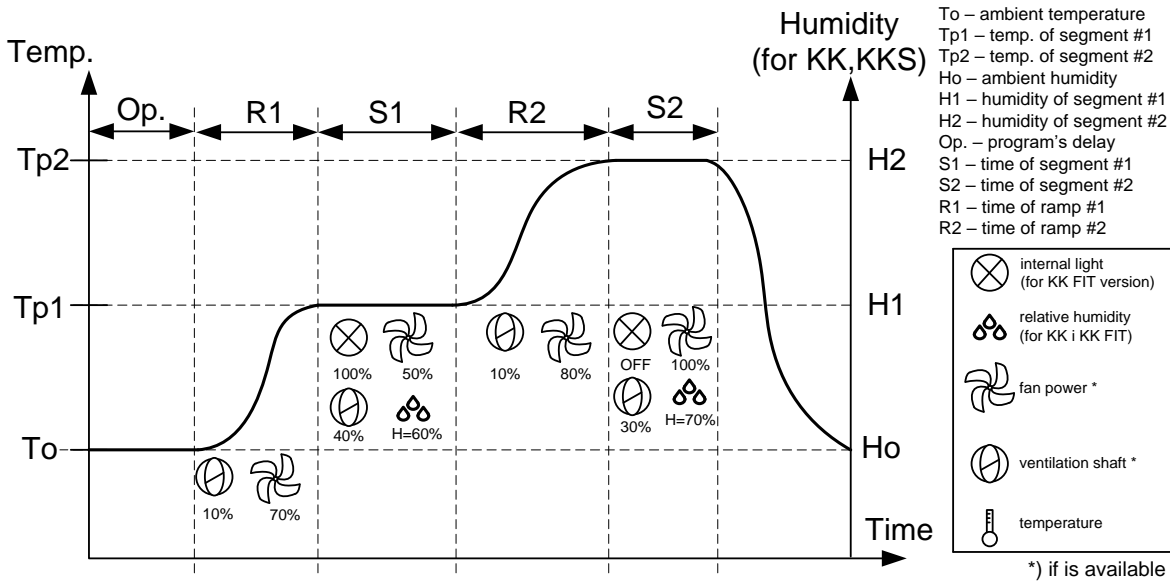

Advanced type differs from the simple type in that apart from setting segment parameters it is possible to define the operating parameters during reaching ("ramp"- time between segments) . It is possible to define the reaching time, the operation of the chamber fan and opening of the air flap (ventilation shaft) if the unit is equipped with them. Each program can include up to 9 segments and 9 ramps.

Advanced Time – time is a priority

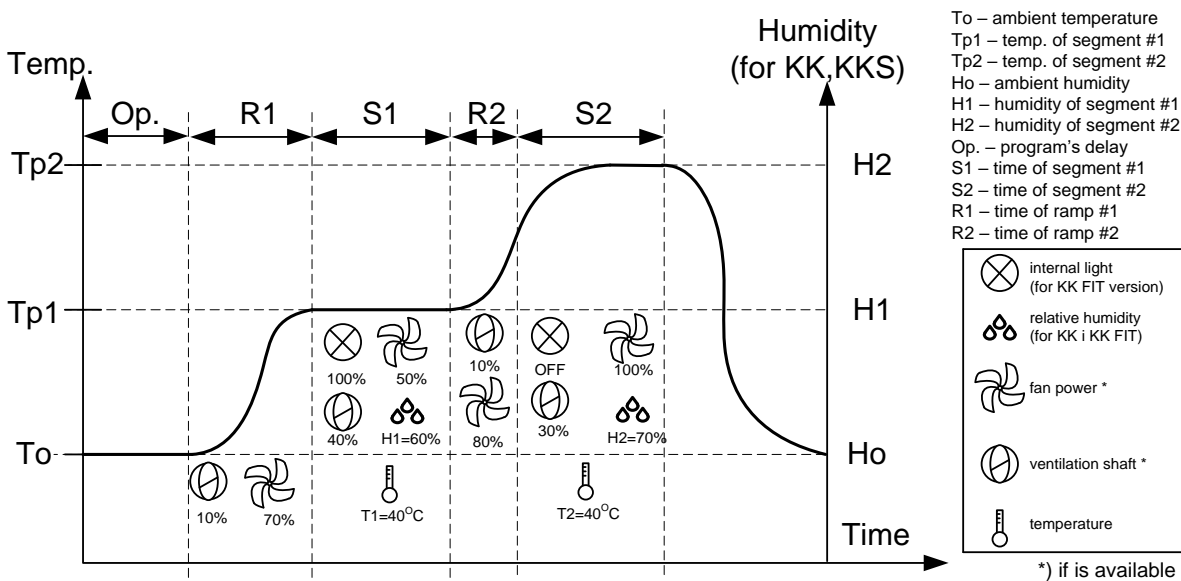

For a complex program, time is a priority. For example, if the Tp2 set temp has not been achieved in segment 2 because the R2 time is too short, the program will start counting segment 2 time as illustrated above.

6 DEVICE OPERATION

The device is controlled using the control panel located in the upper part of the front side of the device.

6.1 Using the keyboard

Sometimes it is necessary to input alphanumeric characters (e.g. to log in to the system, to input User name, etc.). In these cases a keyboard appears on the display. Apart from standard letters there are other characters typical for a computer keyboard.



To control the device it is also necessary to use the following keys:

Esc – used to quit or cancel changes.

Tab – tabulator key, enables easy navigation between editable fields visible on the display.

Shift – enables inputting capital letters (password field during User log in is case-sensitive). To input a capital letter it is necessary to press Shift (the key becomes highlighted) and then the desired letter.

123 – numerical keypad switch, enables inputting numbers. After pressing the **123** key a keypad with digits will appear. To return to letters after inputting digits, it is necessary to press the **123** key again.

◀ - backspace key – enables erasing a typing error. The key erases the character positioned directly in front of the cursor.

↵ - Enter key – confirms provided information.

If the field to input information is hidden under the keyboard, it can be moved by holding the blue bar at the top of the keyboard. The keyboard can be hidden by pressing the  icon. Pressing the icon again will bring the keyboard back. Sometimes input characters can be displayed as asterisks *. This happens when input information is secret (e.g. when typing passwords).

6.2 Turning on the device

To turn on the device, use the main switch located at the front of the device. The welcome screen will appear after turning on the device. The start-up lasts for approx. 1 minute when a self-test of the device's components is carried out.

When the self-test is completed, the display will show the Main Screen. An example screen is shown on the right (for a running program and User logged in).

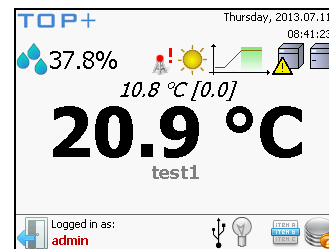

UPS power supply backup

To turn on the unit:

In order to turn the unit on, please proceed with the following steps:

- after plugging the unit to the mains socket, turn the unit ON using the main switch,
- the unit will start soon

further operation of the unit is the same as in case of basic version.

To turn off the unit:

- turn off the main switch on the control panel,
- backlight panel is being turned off,
- it is possible to switch off the unit on the main switch as well.



Use of the main switch of the unit is recommended only in case of longer pause of the unit's operation (at least a few days) or in case of unit's maintains works.

6.2.1 User log in

The device can be controlled (changing parameters, running a program) only when a user is logged in one of the modes: Administrator or User.

The Administrator mode enables setting parameters specific for the device, such as changing the current time, Ethernet settings, adding and deleting Users, etc.

The User mode enables control of the device by editing, adding, running and stopping programs. In user mode it is possible to view and save the record to a portable memory (pendrive).

Factory settings: (login: **admin**, no password). It is recommended to add the admin password after the first run to prevent unauthorized use.

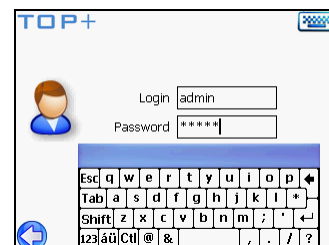

It is necessary to write down and remember the admin password because it is not possible to reset it!
If the password has been lost, it is necessary to contact service.
Resetting the password is not a warranty repair!

To log in you need to:

- 1) Press  in the Main screen. You'll see the screen on your right.

When logging in you'll see the alphanumeric keyboard. Guidelines how to use it are provided in chapter 6.1.

- 2) Press **Login** field. In the editable field you'll see a cursor and below is the keyboard displayed which enables inputting the User name.

- 3) Input the User login and then move on to the **Password** field by pressing it.
- 4) Input the User password. For security reasons the password is hidden by asterisks “*”.
- 5) After providing the correct password confirm it by pressing Enter (the ↵ symbol on the keyboard).

6.3 Main Screen

After turning on the device, the display will show the Main Screen. The screen shows current information about the state of the device and User logged in:

- (1) Relative humidity in the chamber (in KK, KKS and KK FIT)
- (2) Temperature in the chamber. Above this value smaller font is the temperature
 - with additional sensor (option-KK)
 - in the cylinder steam humidifier (for KKS)
 In square brackets the value:
 - compensation (for KK)
 - the current flowing through the electrodes in the humidifier steam (for KKS)
- (3) Information about the User currently logged in. (if

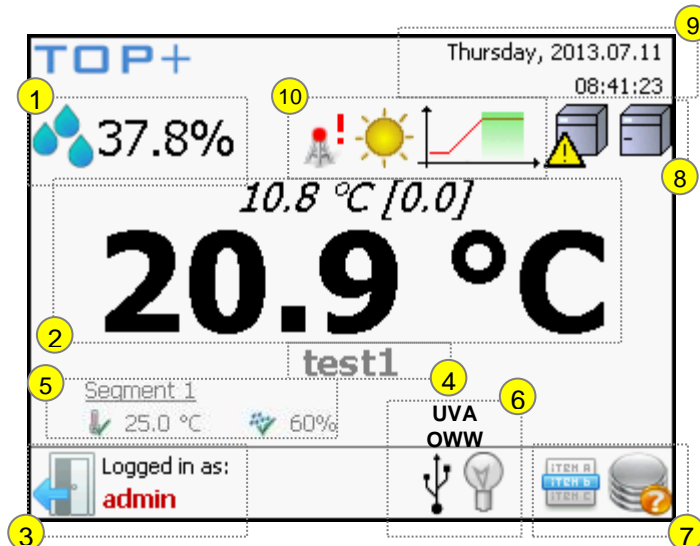

no User is logged in, there is the  - login button)

- (4) Name of the active program
- (5) Current active segment, set temperature and humidity (in KK, KKS and KK FIT)
- (6) Lighting in the chamber (optional), external memory.

Pressing the icon  turns on /off interior lighting (OWW) inside the chamber (indicated by an inscription OWW above the bulb). The interior lighting switches on/off automatically when the door is opened /closed.

The lit bulb  symbolizes the active phytotron (FIT) or photoperiod (FOT) lighting controlled from the program.

The switched on UVA / UVB lighting is indicated by an inscription above the bulb.

 - USB memory is connected. After recognizing the memory, the icon is displayed on the screen. After that, the data is saved on the memory.

- (7) Menu  and Status  buttons are described further in the manual

You can see the  after a successful login

 - this icon informs that a user is logged in remotely. Tap the icon to see the event registry. See point 6.10 for more information

(8) Information on the device. This field can contain the following icons:

 - Icons denoting open or closed chamber door

 - Icon meaning some problems with correct operation of the device (see chapter 11.1)

(9) Current day of week, date and time

(10) Information about the operation of the device during an active program(it is displayed only when a program is active)

 - the device is in the process of heating up the chamber

 - the device is in the process of cooling down the chamber

 - Program delay is active

 - Reaching programmed temperature (reaching programmed temperature mode)

 - Maintaining programmed temperature

 - active defrosting of the chamber (over the icon you will see defrosting time). This Icon appears as well at the times of temperature increase in the chamber.

6.4 **Menu Screen**



The Menu button which opens the *Menu Screen* is available only when a User or Administrator logs in. The menu can have various screens depending on currently logged in person (user or admin).

User screen

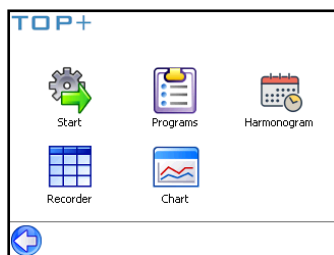

Admin screen

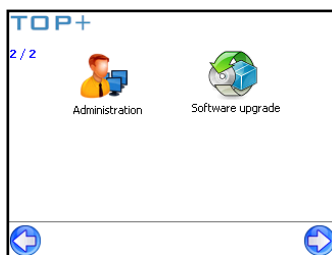

6.5 **Administrator Menu**

The Administrator Menu screen contains 4 keys:

- Users
- Events
- Settings
- Recorder

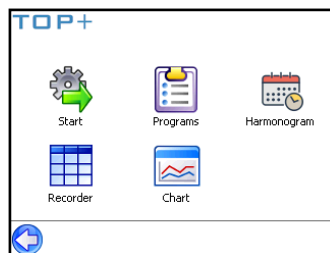

6.5.1 Users

If you tap users, you can manage the accounts.

You can add, remove or edit User accounts in this screen. It is also possible to define how many programs each User can have.

User List screen

The *User List* screen (similar to the one on the right) is available after pressing the **Users** button. This screen provides information about User accounts. Column (1) is a list of account names, column (2) contains passwords for each account, column (3) shows the maximum number of programs defined for each User. It is possible to delete User accounts – by pressing the **Delete** button. You cannot delete the admin account if there is only 1 admin account. The number of programs for each user is shown in (4).

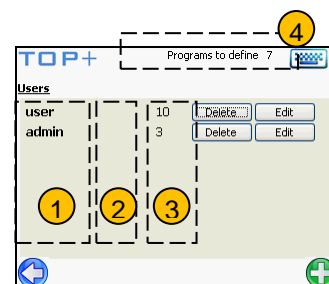

If you tap , you can add another user.

User Editing screen

The **Edit** button enables changing the password and login (user name) of Users and Administrator. After pressing the **Edit** button you'll see the *User Editing* screen. Inputting User login and password is done in exactly the same way as when providing these details during logging in (see chapter 6.2.1). Use the ▲ and ▼ keys to input the number of programs. They are located next to the program number field. You can also choose the account type (user or admin). Press the **Save Or Add** button to confirm.

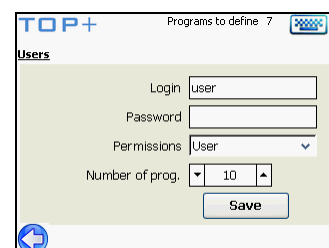

6.5.2 Events

This window contains information regarding the date, operating time and number of logins. You can delete the list by tapping .

To exit, tap .

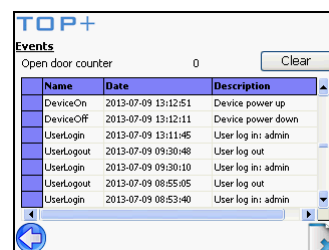

6.5.3 Settings

The system settings menu.

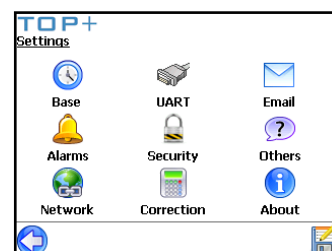

Base – Editing current date and time, change language

To set the date or time press one of the editable fields (e.g. month) and change the value using the < and > keys located next to it. In the same way you can set the current hour, minute and second. NTP is a communication protocol that enables precise synchronization of time between computers. In the NTP window enter the names of the NTP server from which the current date and time should be synchronized. Depending on the country and region of installation select the appropriate time zone. You can also switch between Celsius and Fahrenheit degrees. In this window you can also choose language in which all announcements will be displayed and change the device name.

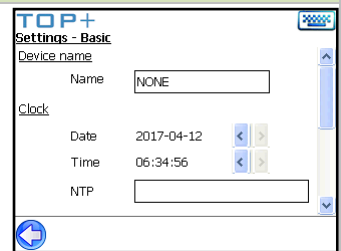

To confirm the new time and date press  button.

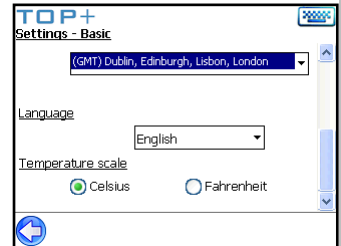

Alarms – Editing alarms

- **Alarm temperature** – activation of alarm when the temperature exceeds. Alarm will go off when during running program, the temperature in the chamber exceeds the set temperature by value of hysteresis. The activation of alarm is signaled by audible alarm and visible alarms: alarm icon in the main view and colour change of the temperature in the main view (blue – over temperature low, red – over temperature high). Hysteresis can be set in the range of 0,5°C to 5°C. *Example: if the set temperature is 155°C and the hysteresis is set on 2°C, the alarm will go off when the temperature in the chamber will achieve below 153°C or over 157°C.*

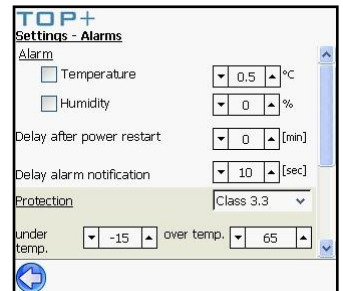

- **Alarm humidity** – the operation is the same as in temperature alarm. The hysteresis of humidity can be set in the range of 1% to 30%RH. After activation of alarm the colour of displayed humidity values is also changed.
- **Delay alarm notification** – time after power restart in which the alarm will not be activated, despite exceeding of set hysteresis.
- **Alarm time** – after this time, an alarm e-mail is sent. Increasing this time allows you to avoid sending e-mails if the temperature exceeds only temporarily the limit.
- **Protection** – enables to set the temperature sample protection class. Protection class selected in this window apply when the unit is turned on without set program. During the program and after the program is finished adopted are adjustments of protection set in the program (see point 7). The operation is described in section 6.

Uart – Setting RS-232 or USB transmission parameters

Network – network parameter settings

The screen is used to set up parameters to connect the device to Ethernet network.

It is not necessary to connect the unit to Ethernet Network. Programming the unit via the EasyLab application or TOP+ control is the same like programming through the control panel. However, the manufacturer recommends to use one of the computer applications since they are more convenient to use. Editing the below settings is recommended (even if the unit is not going to be controlled remotely) because it is possible to calibrate the screen and updating the software. These functions are available by using the computer applications.

To change a parameter it is necessary to press it. Use the ▼ and ▲ keys next to the edited field to change the value.

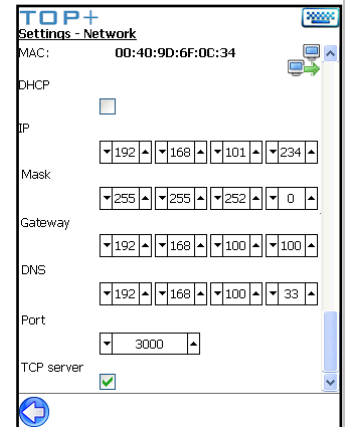

When using EasyLab or TOP+ Control software it is necessary to set up the following parameters:

- **MAC** – physical network adapter address, read only
- **DHCP** – you can tick if there is a server that assigns IP addresses on the local network. You can skip IP, Mask, Gate settings
- **IP** – the IP address of the device
- **Mask** – mask of the Ethernet network to which the device is connected
- **Gateway** – the IP address of the server or router controlling Ethernet network
- **DNS** – the IP address of server DNS

 - **Port** – number of the port through which the device communicates with EasyLab-T Plus or TOP+ Control program

 - **TCP Server** – select this option to control the unit using the TOP+ control or EasyLab-T PLUS programs

Connection status with Ethernet network is symbolized by icons on the right sides



disconnected

connected without access to network

connected with access to network

	<p>If you don't know the Ethernet network settings consult the person responsible for the network. Connection with EasyLab and TOP+ Control programs will be possible only when parameters set for both the software and the device are identical. Incorrect network settings will make it impossible to connect to EasyLab and TOP+ Control programs.</p>
---	--

The screen is used to set up all necessary parameters for a transmission using the RS-232 serial port located at the back of the device. The following parameters are available:

- **Protocol** – defining the transmission protocol

- **None** – no transmission
- **Modbus RTU** – binary Modbus protocol
- **Modbus ASCII** – serial-by-character Modbus protocol
- **EasyLab Professional** – protocol enabling data transmission in EasyLab or TOP+ Control programs
- **Text** – sending parameters in text, this data can be used by connecting a printer or a computer with a Terminal type program
- **Service** – service protocol
- **Service USB**– service protocol with sending data to USB external memory
- **Printer-Epson** – text protocol which works with Epson printers available in POL-EKO-APARATURA offer.

Besides printout of temperature values, additional information such as alarms and summary will be printed.

- **Printer-txt** – text protocol, such data can be used by connecting a printer with RS-232 port or with computer with Terminal type program. Information are sent only when the program is active (during executing segments or achieving set temperature).

- **Baud rate** – setting data transmission rate. Available rates: 2400, 4800, 9600, 14400, 19200, 28800, 38400, 57600, 115200 Bd (bauds - bits per second). 9600 Bd rate is the default value (e.g. during communication with EasyLab-T program using the RS-232 interface)

- **Interval** – setting how often data is to be sent using RS-232 port

- **Address** – the address of the device (e.g. for Modbus protocol)

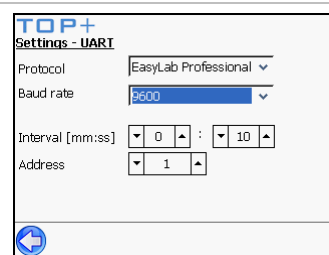

Security – automatic log out adjustment

For security purposes the device allows to automatically log out User or Administrator after specified period of inactivity – log out delay parameter. To do this, select Autologout. Disabling remote log out prevents auto log out of user when trying to connect the unit remotely by using TOP+Control software. If this option is enabled, logging in is possible also when user logged in previously from control panel.

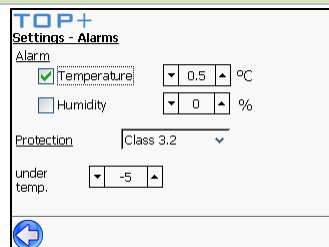

Correction – temperature correction inputted by the User

It allows you to correct the temperature indicated on the display by adding the correction value. The set correction value is taken in the whole temperature range operation of the device. For example, if the average temperature displayed by the device indicates 100°C and the average temperature measured by independent, external sensor indicates 100,5°C, the correction should be set on +0,5°C. The average temperature should be calculated from chosen period of time e.g 30min. The correction range of -5°C to +5°C.

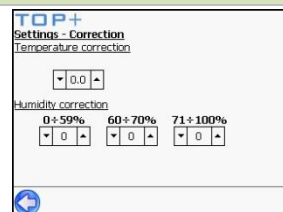

The device has been calibrated by the manufacturer in accordance with applicable norms. The temperature shown on the display corresponds with a great accuracy to the temperature in the geometrical centre of the chamber. For the correct operation of the device it is not necessary to use User's calibration.

The user is performing temperature correction on his own responsibility and s/he must be aware

of consequences of changing of manufacturer's settings. If the equipment was calibrated, calibration certificate loses it's validity.

Email – notification settings

In this window you can set all the parameters required to activate email notifications.

Active – turns on/off the email notifications.

Smtп server, Port, User, Password, Sender – sender parameters.

Recipient1, Recipient2 – email addresses to receive the modifications.

The values which initiate the alarm can be set in the **Alarms** window. After you have set all the parameters, you can send a sample test message by clicking **Send**

Others – additional settings

- **Touch screen calibration** – opening the touch screen calibration screen. If the touch screen is not calibrated, its operation is more difficult.

The system might misinterpret points touched by the stylus. In the calibration screen there appear crosses. The calibration is performed by touching and holding a stylus in the middle of the symbol. The symbols appear a number of times in various areas of the screen. Calibration will finish after correct calibration of the touch screen. Press the Enter sign located in the text in the upper part of the display.

Having finished calibration, press **Save** to save the information.

- **Event log** - pressing the SAVE button enables saving the logged events stored in the internal memory directly to the external flash disk (pendrive) via USB port located on the front of the unit / device.

- **External recorder** – saving registry data to USB memory.

- **Open door alarm** – door alarm delay

- **Minimum fan speed** – min fan speed value that can be set in the program (if the unit has been equipped with chamber fan)

- **Defrosting** – press **START** to start defrosting. See point6.9.

- **Compensation** - The compensation value is a correction for the regulation of the main sensor so as to obtain the desired temperature at the measuring point by additional sensor(if the unit has been equipped with extra sensor).

If you choose compensation, the unit will be controlled according to the extra temperature sensor. Set the **compensation speed** and its **limit**. This parameter determines how quickly the unit will react on temperature differences between the main and extra temperature sensors.

Available settings: 0,1°C /10 seconds 0,1°C /15 seconds, 0,1°C /30 seconds, 0,1°C /45 seconds oraz0,1°C /60 seconds.

Compensation limit– permitted compensation temperature difference from 2°C to 8°C.

- **defrosting period, defrosting time** – (only for KK, KKS and KK FIT range) – the user can define how often the unit should perform defrosting and how long it should last

During defrosting temperature and humidity inside the chamber can fluctuate.

- **Default settings** – pushing the **Revert** button will cause the adjustment of the following values:

About - information on the manufacturer and software version

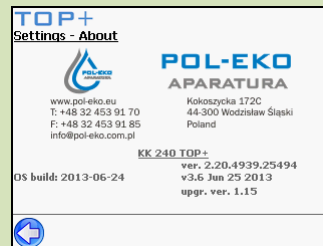

- **Rinsing of humidifier** – (concerns KKS units with steam generators) – it performs a full rinsing of the humidifier, which should be done once every six months. A reminder of the need for this action appears in the alarms and disappears after execution.

KK and KK FIT:

It is recommended that you set the defrosting function to automatic for all single segment programs with set temperature above 20°C. For two or more segment programs, also for day/night simulation, you should set the defrosting function to manual with the following parameters:

Defrosting period: 2hours;

Defrosting time: 120 sec.

6.5.4 Recorder

Use the Recorder button to delete registry entries.

6.6 User Menu

A logged-in User or Administrator has access to the Menu Screen, where the following functions are available:

- Start (if a program is currently running, the button is used to stop it)
- Programs
- Recorder
- Chart
- Schedules

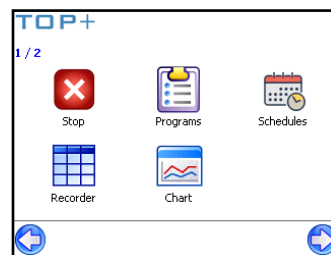

6.6.1 Start

Starting saved programs



It is not possible to run a program while other program is running. Please stop the program to run a new one.

A list of available programs for the User logged in appears after opening the window. Having selected the program and pressed its icon, the device asks for a confirmation of starting a program. Press **Yes** to start the program.



6.6.2 Programs

Editing existing and adding new programs. It contains all programs of the logged user. Each program can be deleted or edited.



You can open the Program Editing Screen by pressing the  button. This will allow you to create a new program.

The Program Editing Screen is shown on the right.

The following parameters can define a program:

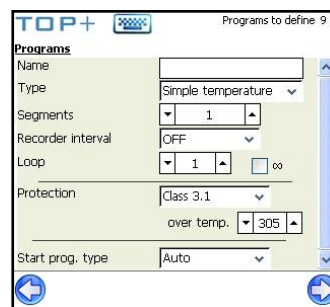

Name – name given by the User

The name is inputted in the same way as during User logging in to the system.

Type – defines the type of the program

It is possible to choose between a simple and advanced type (see chapter 5.4). A list of possible program types is available by pressing the “√” button located next to the program type selection field.

Segments – defines the number of segments for the program

Each program can have up to 100 segments defined. Use ▲▼ to select the number of segments

Recorder interval– defines the frequency of saving data

Defines the frequency of saving data on temperature and relative humidity inside the chamber (option) during the operation of the program. Data is recorded to a recorder (see chapter 6.6.3). Possible interval values are available after pressing “√”. Choose OFF to switch off the recorder.

Loop

You can define if a program should be carried out one (value 1) or more times (from 2 to 99). You can also set the program to be carried out all the time, tick the „∞” option. If a cycle run is active, after finishing the last segment, the program will continue to carry out the first one.

Protection – over/under temperature protection

Enables to set the temperature class protection of samples. Adjustment of protection in the program is applied only during the program and after finishing the program. The operations is described in section 7.

Launching the program- program mode

by pressing the „√” button, the user can choose the program mode. Available options:

- **Auto** – running the program just after start
- **Delayed** – allows to delay the start; choosing this option activates the **delayed start** option described below,
- **7-days** – turns the 7-day program on; it is possible to program every day and hour of use (see 6.8). The above parameters can be set on the next screen.
- **Start delay** – defines (in hours and minutes) the delay of starting the first task; it is counted from starting the program.

Delayed start

determines (in hours and minutes) the delay in carrying out the first task; option available only if the 'delayed' option is active.

After defining the above parameters, move on to editing individual parts of the program by pressing  button.

Depending on the previously selected program type you will see a specific screen.

Simple program

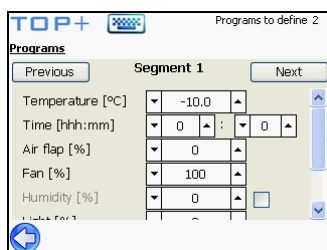

Advanced program

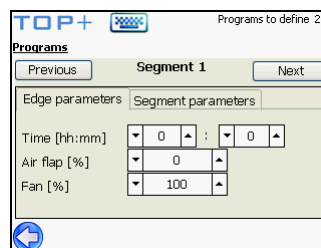

Screens vary depending on the type of the edited program. For both types of programs parameters can be edited using ▲ and ▼ buttons located next to the editable fields.

Temperature – temperature inside the chamber programmed for the given segment



Units with LED panels only: The max temperature for the LED panels is 40°C. Remove the LED panels if you need to work at higher temperatures. Under no circumstances should you set higher temperatures in the unit if the LED panels have not been removed, as it may damage them.

Time – duration of the given program in hours and minutes.

Airflap– defines the opening degree of the air flap in per cent (option).

Fan – defines the operating power of the chamber fan in per cent (option).



For KK, KKS and KK FIT range:
It is strongly recommended that you leave the fan speed at 100% as set by default. If you decrease the fan speed, the chamber may frost, temperature/humidity stability and uniformity will be affected and condensation may occur as a result.

Humidity – (for KK, KKS climatic chambers) determines the humidity in the chamber during each segment

It is possible to deactivate this option.

Light– lighting parameters settings

- for a unit equipped with the phytotron system: brightness adjusted in percentage, every 10%; allows day and night simulation

- for a unit equipped with the photoperiodic system: the light is switched on during a segment if the **LIGHT** parameter is selected

In case the unit is equipped in light panels independent control than brightness regulation is available independently for each panel. Number of the Light parameter (in the control panel) is equivalent to the position of the sockets to which light panels are plugged.

Additionally, the unit can be equipped with UVA or UVB lighting that can be turned on in the same way as the photoperiodic system.

In the advanced type the segment can be also defined by the reaching and maintaining parameters. Select a tab by pressing its name.

After defining parameters of the segment, move on to editing the next one by pressing **Next**. You can return to the previous screen – editing segment by pressing **Back**. Having defined all the segments of the program you will be asked whether you want to save the new program.

The program can be started in the Starting Screen (see chapter 6.6.1).



You can change the parameters while the program is running. All changes will be updated automatically.

6.6.3 Recorder



The opening time of the *Recorder Screen* depends on the number of recorded cells. The more cells are filled in, the longer the window opens.

The *Recorder Screen* contains information about the recorded temperature values, relative humidity (option) inside the chamber and the temperature value from the additional temperature sensor.

There is a total of 4100 cells available. When all the cells are full, new data overwrites existing cells starting from the oldest one. Data is shown in chronological order, from the oldest to the newest entry.

Icon  pens the window of events log.. More information in 6.10.

By pressing  you have the following available:

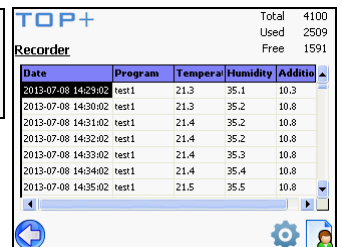

Date	Program	Tempera	Humidity	Additi
2013-07-08 14:29:02	test1	21.3	35.1	10.3
2013-07-08 14:30:02	test1	21.3	35.2	10.8
2013-07-08 14:31:02	test1	21.4	35.2	10.8
2013-07-08 14:32:02	test1	21.4	35.2	10.8
2013-07-08 14:33:02	test1	21.4	35.3	10.8
2013-07-08 14:34:02	test1	21.4	35.4	10.8
2013-07-08 14:35:02	test1	21.5	35.5	10.8

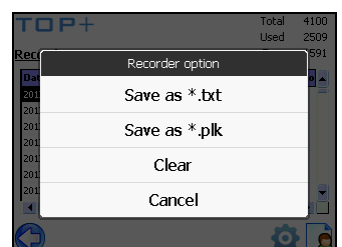

Recorder option

Save as *.txt

Save as *.plk

Clear

Cancel

Save as *.txt – enables saving the contents of the recorder to a portable memory (pendrive) in a text file. The name of the file includes the file creation date and time, as well as the word “Recorder”. For instance the file 200905241118Recorder.txt has been created on 24 May 2009 at 11:18.

The file is saved in text format with tabs between columns; this enables the file to be used in MS Excel or another spreadsheet.

Save as *.plk – Registry data can be saved in EasyLab (*.plk) format and opened in the EasyLab-T PLUS program. The information can be used to create charts, calculate average temperature values etc.

The USB socket, to which portable memory can be connected is located at the control panel of the device.

	Recommended maximum length of USB cable is 4 meters and of RS232 is 15 meters. Longer cable can cause errors in operation.
---	--

	USB slot is used to connect a flash memory – a pendrive. Connecting other devices (external hard drives) or any other is not authorized by the manufacturer and may damage the USB slot.
---	--

The registry may be saved all the time on USB memory. To use this function, see point 6.5.3 Others.

	If the direct save function is active, the registry will be saved only when the USB memory is connected.
---	--

Using USB memory bigger than 2GB takes more time for the instrument to recognize the memory by the unit.

After recognizing the memory, the  icon is displayed on the screen (point 6.3). After that, the data is saved on the memory.



Clear – clearing data from the recorder.

6.6.4 Chart

The *Chart Screen* presents the temperature curve.

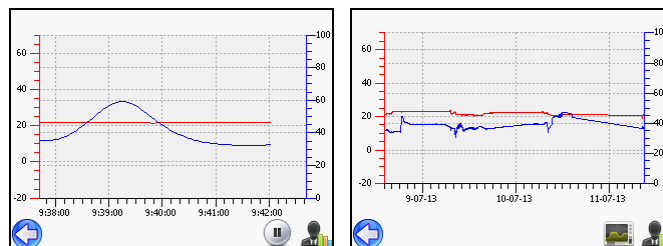
The chart is constantly updated. It is impossible to view a previously created chart. Temperature values needed to create the chart are recorded every 5 seconds. The chart includes information from the last minute.



Tap the  to overview the temperature recorded in the registry. The  icon informs about an active temperature overview.

6.6.5 Schedule of programs

Allows to create list of programs which might be realised in specified time intervals. You can create several independent harmonograms.

Schedule is available in **Menu** (opens when clicking  icon on the **Mainscreen**). **Main screen** is available after logging (by Admin or User).



Before creating Schedule - create programs that are to be used in it!

Window **Schedules** contains list of all already created schedules of logged in User.

By  button you can add new schedule.

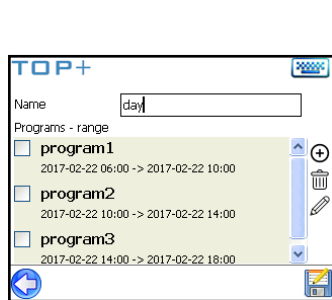
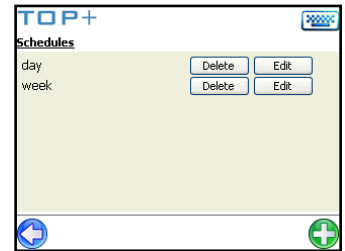

When you click **Edit** or  the window to manage the selected schedule will opens. You see a list of programs (queue), along with the time periods in which they will be launched.



Name – name of schedule – any name given by the user,



 - adds new program to the schedule (program needs to be created earlier),

 - delates from list (queue) currently selected item,

 - edit - make changes in the selected item,

 - save the schedule

By clicking  or  the controller will display a window which allows to select the program as well as date and time of its start and finish.

 - clicking  allows to select a program from a drop-down list

 - date and time of starting the program,

 date and time of finishing the program,

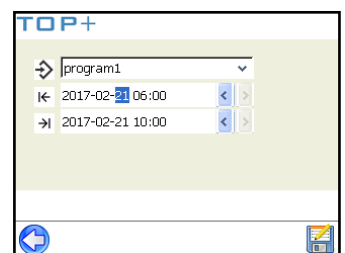

When creating the schedule you should take into consideration the following restrictions:

- time of start position in the queue cannot be earlier than the current date and time,
- time of start position in the queue cannot be earlier than time of finishing of previous position in the queue,
- time of finishing position in the queue cannot later than next position in the queue time of start,
- time of finishing position in the queue cannot coincide with the start time of next position but may be a break between them,
- if the program is not totally completed (because of a too short time schedule) it will be interrupted.





When selecting intervals should be considered whether they are long enough that the selected program can be executed. The duration of the program may be affected by: environmental conditions, workload, program carried out directly before it.

Schedule can be launched in two ways:

1. During saving of Schedule you can use option 'Save and start',
2. Using **Start** in **Menu** window – when opening the window a list of all available Programs and Schedules of logged in User

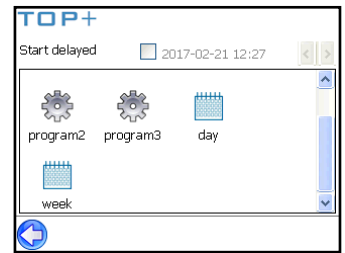
Schedules are indicated by  icon.



Launched schedule in the main window is marked with an icon .

6.7 Status Screen

You don't have to log in to see the *Status Screen*. This screen contains information about the operation of the device.

To leave the Status Screen, press .

In the status window you can change the segment parameters quickly after tapping the program name.

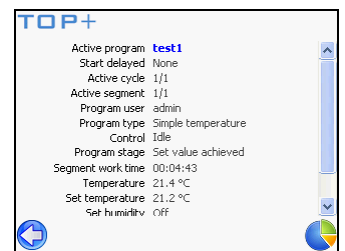

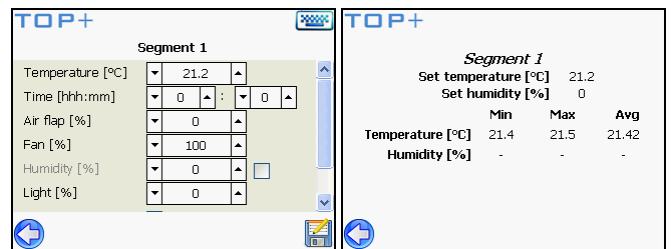

Once the set value has been reached, you can view the min, max and average temperature values when you tap .



6.8 7-day program mode

After choosing this option and pressing the , the following screen will appear on the display.

Tick the days on which the program will be active and set the time.

Use the buttons  and  to set the time. Highlight the hours and minutes first to change them.

After setting the time, press the  button and move to the next window.

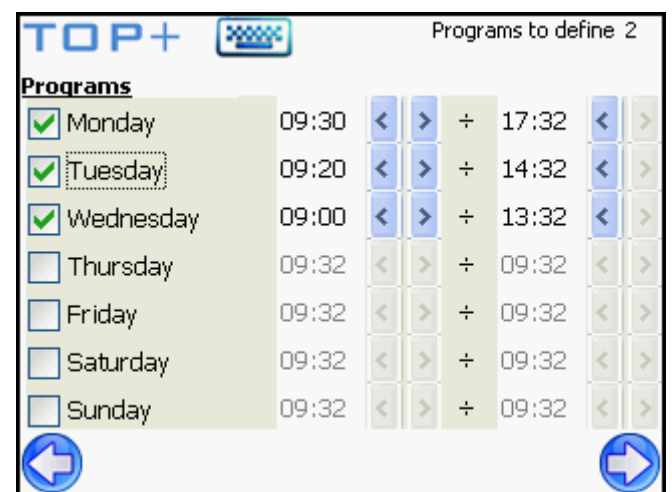

If the set hours will be shorter than the segment time, the program will be stopped. The program will start on the next day at the set time and will be carried out from the beginning, i.e. from the 1st segment.

Running the program is the same like other programs. (see point 6.6.1).

 00:00 time equals 24:00.

 If you need the program to work for 2 or more days continuously, you need to set the start time of the next day at 00:00 and the finish time of the current day at 00:00, otherwise the program will stop at midnight.

Example:

If you need the program to work continuously Wednesday, you need to Mark Monday, Tuesday and Wednesday as active days. After that, the working days for Monday will be 10:00-00:00, for Tuesday 00:00-00:00 and for Wednesday 00:00-17:30.

6.9 Defrosting function

Some of the TOP+ units that come with a cooling system feature a defrosting function that can be launched when a Administrator is logged in. The heaters will turn on for a while to defrost the chamber. If the defrosting function is active, no other program can be launched. To start defrosting, you need to stop the active program first. If the defrosting function is active, you will see the following icon  on the display with a number over it that indicates the defrosting time.

 After defrosting has finished, you need to wipe out the chamber. This will reduce the risk of quick frosting of the chamber.

Defrosting takes 30 minutes and stops automatically. It can be stopped manually too at any time.

6.10 Events identifier

The user can make notes during operating time of the unit and store them in the memory. To make a note, perform the following steps:

- if you are logged in remotely, tap the  icon on the display

- if you are not logged in remotely, go to Menu and open Recorder. Tap the  icon to open the events identifier.

Choose the event's type:

advanced – an event will be seen by the Admin and in the TOP+ Control or EasyLab application

simple – an event will be seen on the events list only

Fill in the message field and press **Add**. A note has been added.

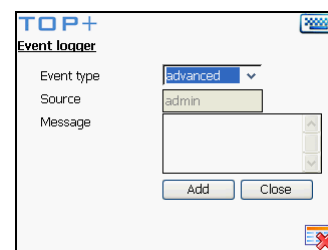

 If you want to see the events identifier in the TOP+ Control or EasyLab application you need to launch the application and log in remotely.

7 OVER/UNDER TEMPERATURE PROTECTION

The unit is factory equipped with samples protection – over/under temperature protection, which is realized on the basis of temperature value measured on the second, independent temperature sensor (protection sensor). The purpose of samples protection is to protect from uncontrolled raise or drops of the temperature. At the time of operation, the transmitter disconnects the power supply circuit.

There is 4 classes of protection:

2.0 class – over temperature protection – no automatic switch on the circuit when the temperature go down below the set value protection – intervention of the user is required.

3.1 class (CL, SL) – over temperature protection – automatic switch on the circuit when the temperature go down below the set value protection

3.2 class – under temperature protection - automatic switch on the circuit when the temperature raise above the set value protection

3.3 (ST,CHL,ILW,KK,KKS) – under and over temperature protection – combination of class 3.1 and 3.2.

In class 3.x – in case of damage, the temperature will oscillate around the set temperature protection value.

During setting the value of protection, please note that when achieving the temperature and after opening the door the set temperature may exceed by 2%. If the temperature value of protection will be set to ‘close’ to set temperature in program, it may cause unexpected activation of the protection. It is especially important in 2.0 protection class because after activation, the intervention of the User is needed to keep the unit to maintain the set temperature.

It's recommended to set the values to:

- over temperature protection: 10°C above set temperature
- under temperature protection 10°C below set temperature

The activation of protection generates audible alarm and display the alarm icon.

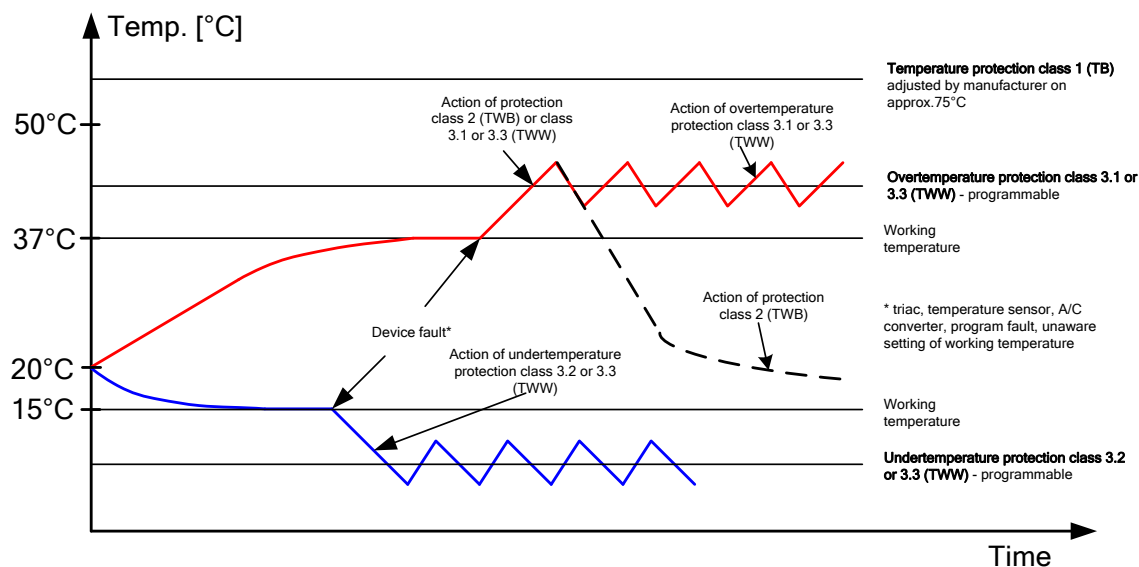

8 REMOTE CONTROL OF THE UNIT

Every TOP+ unit can be connected to the Ethernet network and controlled remotely using the TOP+ control program developed by POL-EKO-APARATURA. The features of the program have been described in a separate instruction manual.

9 TAKING CARE OF THE DEVICE IN CASE OF LONGER ABSENCE

1.	Remove all objects from the chamber.
2.	Disconnect the device from the mains
3.	Clean and dry the chamber.
4.	Leave the door open to avoid nasty smells.
5.	Store in temperature between 0°C and 50°C and relative humidity maximum 70%.
6.	For KK, KKS and KK FIT spin off the water supply.

10 MAINTENANCE

	Before cleaning the device, it needs to be disconnected from the electrical supply!
---	--



	While cleaning, you should always use gloves to prevent your hands from injuries.
---	--

To clean products made of stainless steel (INOX) we recommend using cleaning solution dedicated particularly to stainless steel material. It preserves the steel surface from permanent stains and at the same time retains aesthetic appearance of the product. Recommended cleaning solution is in POL-EKO-APARATURA offer.

INOX products are manufactured with stainless steel. When used in standard laboratory conditions they do not rust. However it is possible that stains (which may look like rust) form on the steel surface (e.g. due to the kind of samples that are incubated in the chamber). In such case we recommend using cleaning solution (to clean the stains) which is dedicated to this particular application, e.g. Pelox.

	When cleaning stainless steel product with dedicated cleaning solution, one should pay attention to the suggestions and recommendations given in the user manual (or in the safety data sheet) of the cleaning solution.
---	---

Exterior cleaning

1	Clean the housing of the unit at least once a week or even more often depending on the conditions in the place the unit works.		
2	The housing and door should be cleaned with caution using a soft cloth dampened with water.		
3	Only mild cleaning products should be used to clean the device.		
4	<p>Unit with cooling system: laboratory refrigerators (CHL), thermostatic cabinet (ST), cooled Incubator (IL), climatic chamber (KK, KKS)</p> <p>Clean the compressor and the evaporator with a vacuum cleaner, dry cloth or a brush at least once a month! The compressor and the evaporator are located in the upper part of the unit (models:500, 700, 1200, 1450) or bottom part (models:53, 115, 240, 350, 400, 750)..</p> <p>In KK 115/240/350, pull out the cover to get to the evaporator. After cleaning, mount it. again.</p>		
			
	<p align="center">KK 115, 240, 350, 400, 750 KKS 115, 240, 400, 750 IL – All models</p>	<p align="center">ST 1, 2, 3, 4, 5, 6, CHL 1, 2, 3, 4, 5, 6,</p>	<p align="center">KK 500 700 1200 1450 ST 500, 700, 1200, 1450 CHL 500, 700, 1200, 1450</p>
If you do not do this, you may break the compressor and lose the warranty rights!			
5	Electrical parts should not get in contact with water or detergent.		
6	Clean the touch screen using a soft cloth for touch screens. It is also possible to use a foam for cleaning touch screens.		
7	USB connector to be cleaned with a vacuum cleaner to prevent accumulation of dirt inside the socket.		

Interior cleaning

1.	The chamber should be emptied of any samples before cleaning.
2.	Open the door of the device and wait for the frost to melt (in case of working in low temperatures), take out the shelves and start cleaning the device,
3.	Only water or water with mild detergent should be used.
4.	Having finished cleaning, you should allow the device to dry fully and fit all parts removed before cleaning.
5.	During cleaning you should make sure not to damage the temperature sensor built in on the top of the chamber.
6.	In drying oven (SL) could happened the internal bottom metal part becomes discolored. It is caused by very high heaters temperature which are placed just under bottom metal part. Change of color of the sheet does not cause any malfunction.

10.1 REPLACEMENT LAMPS

The lamps are installed in FIT versions of the units to simulate day/night conditions. They are mounted under shelves. In the KK 350 FIT the lamps are mounted in the side walls and door. To replace them you need to act similarly like in the case of cleaning the glass in the side walls and door. You need to check the conditions of the lamps periodically. If the lamp brakes down, you need to replace it as soon as possible to keep the optimal working of the unit. The lamp must be identical with the original. The lamps are wear parts and are not subject to warranty.



Worn-out lamps should be disposed at waste disposal points or put into special containers.
 The mercury inside the lamps is dangerous to the environment and human health.
 Do not break the lamps.

10.2 LED lighting

The unit can be equipped with LED lighting panels which are not subject to warranty repairs as they are wear parts.

	<p>Limit the operating temperature of LED panels is from 10 ° C to 50 ° C If you set a temperature with a different value, pull out the shelf with the LED panel. Failure to follow this instruction may result in destroy to the LED lighting.</p>
--	--

10.3 Optional UPS backup battery

1.	The battery is maintenance-free.
2.	The life time of the battery is ca. 4 years. It is recommended that the battery is replaced every 4 years to provide uninterrupted operating. Contact an authorized POL-EKO-APARATURA's service.

11 TROUBLESHOOTING

11.1 Alarm Window

If there appears the  symbol in the *Main Screen*, this means that there have been some problems during the operation of the device. If you click the symbol, you will open the *Alarm Screen*. It contains information about activated alarms together with the time they were activated. The number next to the alarm denotes how many times the alarm was activated.

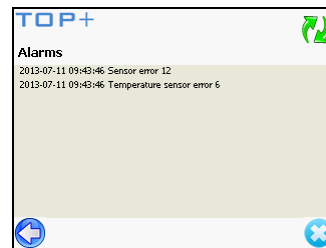

The  button allows deleting information about alarms, including the error counters.

The  icon is used to refresh information about alarms.

The  icon allows disabling the alarm sound of the opened door sensor (if you need to keep the door open for a long period of time).

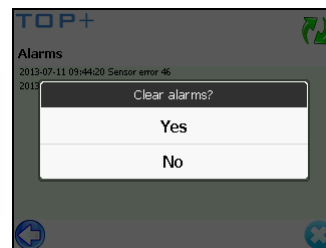

You can leave the *Alarm Window* by pressing .

11.2 Alarm list

Below is a list of alarms which can occur during the operation of the device.

Error	Error description	User's action
Sensor error	Temperature sensor damage	Restart the device. If the alarm recurs, call the service
Range overflow	Temperature measurement has detected temperature value higher than the allowed maximum	Restart the device. If the alarm recurs, call the service
Offset_T LO	Measured temperature is below the allowed temperature range	Restart the device. If the alarm recurs, call the service
Offset_T HI	Measured temperature is above the allowed temperature range	Restart the device. If the alarm recurs, call the service
Protection LO	Low temperature inset protection activated (see chapter 6), caused by too low temperature of the inset or damage of the cooling system	Remove from the chamber any objects which are too cold and might cause a fall of temperature. Restart the device. If the problem recurs, call the service.
Protection HI	High temperature inset protection activated (see chapter 6), caused by too high temperature of the inset or damage of the heating system	Remove from the chamber any objects which are too hot and might cause a rise of temperature. Restart the device. If the problem recurs, call the service.
CH1-error	Temperature slotted line damage	Restart the device. If the alarm recurs, call the service

OCHR dT/dt	Too rapid change of temperature caused by damaged heater control system	Restart the device. If the alarm recurs, call the service
Open door	The door has been open for more than 1 minute	Close the door or disable the alarm sound
Humidity sensor error	Humidity sensor damage	Restart the device. If the alarm recurs, call the service

11.3 Troubleshooting

Malfunction	What to check	What to do
The unit is not working	Check the voltage in the socket	Measure the voltage in the socket; if necessary, change the fuses in the electric installation in the building
	Check if the unit is plugged in	Plug in the unit
	Check the fuse of the unit	Change the fuse
	Check if the power cable is not broken	Change the cable
The unit is not cooling down	Check if the evaporator is not dirty	Clean the evaporator
	Check if the unit is not exposed to a direct sunlight	Change the location of the unit
	Check if the unit is not located near a radiator	Change the location of the unit
	Check if the door of the unit is closed properly	Clean the gasket
The touch screen does not work correctly	The display turns off after launching the unit	Usual phenomenon (see point 5.2)
	Improper interpretation of the buttons	Calibrate the touch screen
The unit is working too loudly	Check if the unit is not touching other objects (e.g. furniture etc.)	Remove other objects
Sagging or tilted doors	Check if the doors are properly leveled. (see chapter 3).	If the doors are correctly leveled and still are sagging, please contact service.
Humidifier does not make steam (for KK and KKS units)	Adjustment of steam is off.	Switch on the humidity adjustment (see point 5.6.2)
	The water supply is closed.	Open the water valve
	No water in the container (for KK)	Refill the container



In ILW, KK and KK FIT: Buzz and noise from decompression coming from the cooling circuit are normal noises.

11.4 Software update

In case the device needs to be updated, you should get all the files from the manufacturer and copy it to the USB root directory.

When the files are copied, put USB memory stick into the USB socket in the unit.

The update can be performed by a person logged to the unit as Admin. To do this, choose software update and proceed according to displayed instructions. After finishing the update, the device will restart.

11.5 Declared runtime of humidifier components UCAN

	For KKS the cylinder of humidifier has to be exchanged once a year. This is a component of humidifier – a wear part and is not a subject to warranty replacement. Below is the description for KK with ultrasonic humidifier.
---	---

UCAN Manufacturer declares failure-free work of components located in humidifier for a specified period of time.

Subgroup	Component	Type	Declared runtime
1	Electronic board for oscillator	UP-015A	2 years or 5000 h
1	Oscillator	UO-30	2 years or 5000 h
1	Set of oscillators	UP-015A/UO	2 years or 5000 h
2	UV Lamp Power Supply	UV-INV/ER	3-4 years or 10000 h
2	UV Lamp	UV-L01	2 years or 10000 h
2	UV Lamp set	UV-UNT	2 years or 10000 h
1	Power control board	UP-003D	3 years or 10000 h
1	Electronics board of DC power supply	UP-032(8A)	5 years or 10000 h
1	Water level sensor	FS-0684A, FS-0683A	4-5 years or 10000 h
1	Electrovalves	VCW21-8G AC48V VCW32-8G AC48V	3 years or 10000 h

In Menu **SETTINGS>Info** duration of work of individual components can be shown, including the operating time of humidifier and UV lamp. Operation time of humidifier applies to subgroups 1 and the operating time of the device refers to the subgroup 2. Subgroups can be visible in the above list. Components of humidifier are wear parts therefore cannot be replaced under warranty, if the operation time of the device is longer than the time declared by the humidifier manufacturer. In case of failure of any component, contact an authorized service manufacturer. Only authorized service is able to reset the timers operation

TOP+	
Ustawienia - Info	
Czas pracy podzespołów	
Licznik pracy kompresora	Brak
Czas pracy nawilzacza	0.00h
Czas pracy urządzenia	Brak
Czas pracy świetlówek	0.00h
KK 750 TOP+	
SN: SWY/3579	ver. 2.25.5038.18128
OS build: 2013-10-03	v3r7 Oct 15 2013
	upgr. ver. 1.15
	

12 WARRANTY

Warranty conditions shall be subject to Polish law

Support form and warranty conditions are specified on the manufacturer's website:

<http://www.pol-eko.com.pl/en/service>

Warranty repairs have to be reported to:

POL-EKO-APARATURA Sp.j.
ul. Kokoszycka 172 C
44-300 Wodzisław Śl.

Tel:
+48 32 453 91 96
+48 32 453 91 70
+48 32 453 90 30

E-mail:
export.service@pol-eko.com.pl

13 EXTERNAL REGISTRATION TEMPERATURE

EasyLab Professional program enables to register the temperature and humidity in thermostatic devices manufactured by POL-EKO-APARATURA.

By this program the User is able to register test results (continous, single) as well as store this data and browse in tabelar or graphic form. Registering is made through RS 232 or USB cable (cables to be ordered separately). Recommended maximum length of USB cable is 4 meters and of RS232 is 15 meters. Longer cable can cause errors in operation. In case ordering device with additional temperature Pt 100, in EasyLab Professional you can parallely register data from both sensors. Additionally, EasyLab Professional allows to program devices in TOP+ version, thanks to integrated application TOP+ Control. The software is free of charge.

EasyLab Professional is equipped with quality tools for creation of charts and approximation. By the program User is able to:

- Generale raports,
- import of data stored on external memory,
- 12 languages as option.



14 RATING PLATE

The rating plate is located on the left wall of the unit, in the upper left corner.

An example of the rating plate:

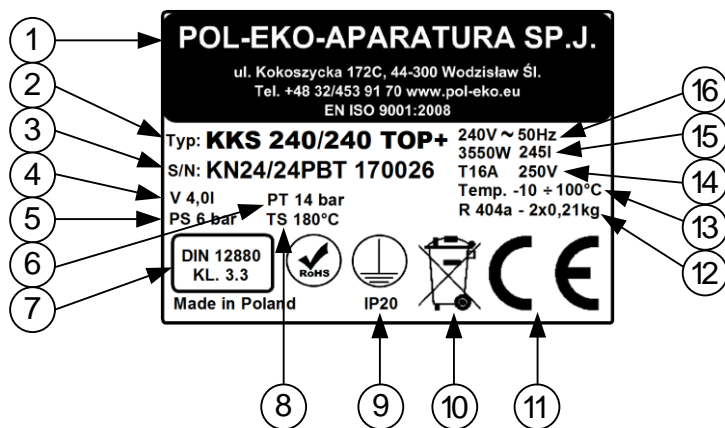

Legend:

1. Name and address of the manufacturer
2. Type of the unit
3. Serial number(2 indicated numbers state the year of production of the device)
4. Furnace capacity (only for KKS)
5. Maximum allowable pressure furnace (only for KKS)
6. Test pressure(only for KKS)
7. Safety class according to DIN12880
8. Maximum allowable temperature(only for KKS)
9. Electric shock protection: protection against indirect contact and housing protection level
10. Disposal of the unit according to WEEE2
11. CE mark
12. Quantity and type of gas in the cooling system
13. Temperature range
14. Type and weight of refrigerant
15. Power consumption, Weight of the unit and Chamber capacity
16. Voltage and Frequency of mains

Under the rating plate there is a label with the license number for the controller's software. A license is assigned to a given instrument.

15 ENVIRONMENTAL PROTECTION AND DISPOSAL OF THE UNIT



The packaging protects the unit from any damage during transportation. The packaging is harmless to the environment and can be recycled. Please handle it according to the environmental protection regulations or dispose it. The unit itself can be recycled in order to save the resources. The unit is marked according to European Union directives on waste electrical and electronic equipment (WEEE2). This directives determine the return and recycling conditions and are valid in all European Union member states.

PLEASE HELP US PROTECT THE ENVIRONMENT!

16 TECHNICAL DATA

The technical data allows for ± 5% tolerance. Usable capacity is always less.

SL, CL, IL

Parametr		SL15 CL15	SL32 CL32	SL53 CL53	SL115 CL115	SL180 CL180	SL240 CL240	SL400 CL400	SL750 CL750	SL1000 CL1000	
air convection		natural (N)/forced (W)						forced (W)			
chamber capacity ¹ [l]		15	32	56	112	180	245	424	749	1005	
door type		solid		solid/door with viewing window(option)							
temperature range	SL	+ 5 ⁰ C above ambient temperature...+300 ⁰ C 41 ⁰ F above ambient temperature...572 ⁰ F									
	CL	+5 ⁰ C above ambient temperature...+100 ⁰ C +41 ⁰ F above ambient temperature... 212 ⁰ F									
temperature resolution ⁰ C]		every 0,1									
controller		microprocessor with external LCD graphic display									
interior		acid- proof stainless stell to DIN 1.4301									
housing	-	powder coated sheet									
	INOX/G	stainless stell linen finish									
overall dims ² [mm]	A width	510	590	590	650	650	810	1010	1260	1260	
	B height	550	630	700	850	1030	1200	1430	1600	2000	
	C depth	440	500	600	700	760	760	750	850	850	
internal dims [mm]	D width	320	400	400	460	470	600	800	1040	1040	
	E height	230	320	390	540	720	800	1040	1200	1610	
	F depth	200	250	360	450	560	510	510	600	600	
max shelf workload ⁵ [kg]	-	10	10	25	25	25	25	25	-	-	
	PW ³ version	-	-	50	50	50	100	100	100	100	
max unit workload [kg]	-	20	30	40	60	75	90	120	140	-	
	W ⁴ version	-	-	80	120	120	300	300	300	300	
nominal power[W]		See rating plate									
weight [kg]		27	35	50	65	94	126	174	260	330	
over temperature protection		class 2.0 according to DIN 12880/class 3.1(option)/3.1 in TOP+									
power supply	SL	230 [V] ±10% / 50 [Hz]						400 [V] ±10% / 50 [Hz] 3P+N+PE			
	CL	230 [V] ±10% / 50 [Hz]									
shelvesfitted/max		1/2	1/3	2/5	2/7	3/9	3/10	3/14	5/16	6/22	
warranty		24 months									
manufacturer		POL – EKO APARATURA									

1. working capacity of chamber can be smaller,
2. depth does not include 50mm of power cable
3. reinforced shelf,
4. reinforced version,
5. on uniformly loaded surface

All the above technical data refer to standard units (without optional accessories)

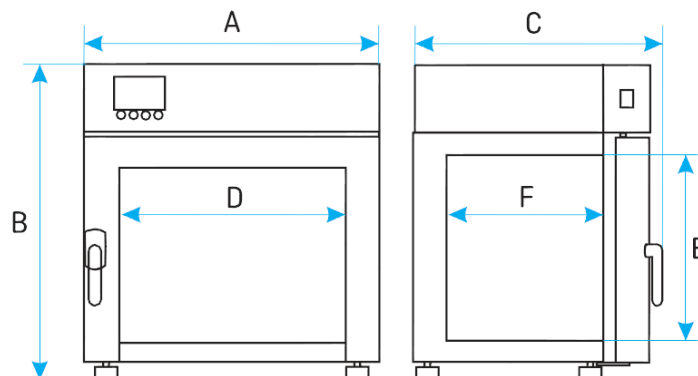

SL CL 15-1000

Parametr	ILW 53	ILW 115	ILW 230	ILW 400	ILW 750	
air convection	forced					
chamber capacity ¹ [l]	56	112	245	424	749	
door type	double/ door with viewing window (option)					
temperature range ² [°C]	-10(option) /0...+70(+100 for TOP+ version)					
temperature range ³ [°F]	14(option)/32...158(212 for TOP+ version)					
temperature resolution ⁴ [°C]	every 0,1					
controller	microprocessor with external LCD graphic display					
interior	acid-proof stainless steel to DIN 1.4301					
housing	-	powder coated sheet				
	INOX/G	stainless steel linen finish				
overall dims ² [mm]	A width	690	660	820	1040	1260
	B height	960	1080	1430	1650	1820
	C depth	600	710	760	740	860
internal dims [mm]	D width	400	460	600	800	1040
	E height	390	540	800	1040	1200
	F depth	360	450	510	510	600
max shelf workload ⁵ [kg]	-	25	25	25	25	-
	PW ³ version	50	50	90	120	140
max unit workload[kg]	-	40	60	90	120	140
	W ⁴ version	80	120	300	300	300
nominal power[W]	See rating plate					
weight[kg]	69	90	140	185	275	
over temperature protection	class 2.0 according to DIN 12880/class 3.3(option)/3.3 in TOP +					
power supply	230 V 50 Hz					
shelves fitted/max	2/5	2/7	3/10	3/14	5/16	
warranty	24months					
manufacturer	POL – EKO APARATURA					

1. working capacity of chamber can be smaller,
2. depth does not include 50mm of power cable
3. reinforced shelf,
4. reinforced version,
5. on uniformly loaded surface

All the above technical data refer to standard units (without optional accessories)

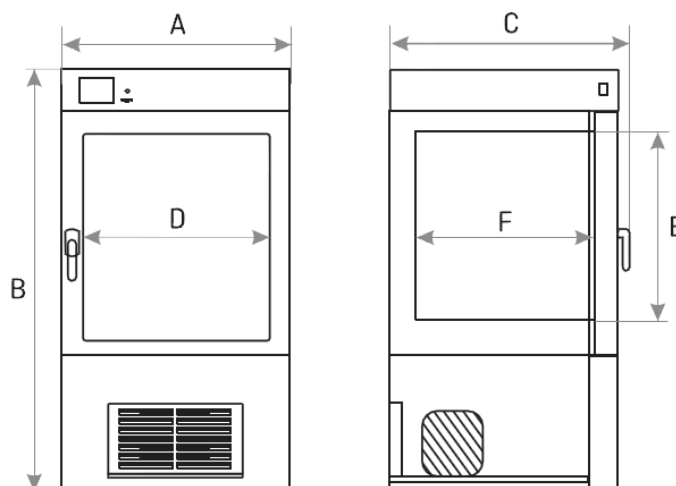

ILW 53 - 750

KK, KKS

Parametr		KK115	KK240	KK350	KK400	KK500	KK700	KK750	KK1200	KK1450	
air convection		forced									
chamber capacity[l]		112	245	335	424	493	625	749	1365	1467	
working capacity[l]		112	245	335	424	386	450	749	1229	1307	
door type		double(external solid ,internal glass)/external glass (option)									
temperature range[°C]	-	-10...+60									
	FIT version	-10...+60°C(with light on +10...+50°C)									
temperature range[°F]	-	14...140									
	FIT version	14...140°F(with light on 50...122°F)									
temperature resolution[°C]		every 0,1									
relative humidity range[%]		30...90 (see working temperature and humidity chart for details on page 55)									
humidity resolution [%]		every 1									
controller		microprocessor with external LCD graphic display									
interior		acid –proof stainless steel to DIN 1.4301									
housing	-	powder coated sheet									
	INOX/G	stainless stell linen finish									
overall dims ¹ [mm]	A width	650	810	640	1020	630	730	1250	1460	1440	
	B height	1160	1600	2000	1840	1990	2000	2000	1990	1970	
	C depth	960	1000	980	1000	1040	1070	1100	1070	1170	
internal dims[mm]	D width	460	600	500	800	510	600	1040	1310	1340	
	D´ width	-	-	-	-	510	600	-	1360	1300	
	E height	540	800	1340	1040	1510	1510	1200	1510	1460	
	F depth	450	510	500	510	640	690	600	690	750	
	I height	-	-	1270	-	1380	1360	-	1360	1300	
max shelf workload ² [kg]	-	10	10	10	10	20	30	-	30	30	
	PW ³ version	50	100	100	100	100	100	100	100	100	
max unit workload[kg]		60	90	100	120	100	150	140	300	300	
nominal power [W]		See rating plate									
total maximum power of electrical outlets (optional)		$\Sigma_{max.} 200 [W]$									
weight [kg]		90	140	125	185	130	170	275	220	230	
over temperature protection		class 3.3									
power supply		230 [V] ±10% / 50 [Hz]									
shelves fitted/max		2/7	3/10	3/11	3/14	3/11	3/11	5/16	2x3/11	2x3/11	
warranty		24 months									
manufacturer		POL-EKO-APARATURA									

1. external dimensions for units without FIT option, depth does not include 50mm of power cable
2. on uniformly loaded surface,
3. reinforced shelf.

All the above technical data refer to standard units (without optional accessories)

Parametr		KKS 115	KKS 240	KKS 400	KKS 750
air convection		forced			
chamber capacity[l]		112	245	424	749
working capacity[l]		112	245	424	749
door type		double (external solid , internal glass)/external glass (option)			
temperature range[°C]	-	-10...+100			
	FIT version	-10...+60(with light on +10...+50)			
temperature range[°F]	-	14 ...212			
	FIT version	...14...+140 (with light on 50...122)			
temperature resolution[°C]		every 0,1			
relative humidity range[%]		30...90 (see working temperature and humidity chart for details on page 55)			
humidity resolution [%]		every 1,0			
controller		microprocessor with external LCD graphic display			
interior		acid – proof stainless steel to DIN 1.4301			
housing	-	powder coated sheet			
	/INOX/G	stainless stell linen finish			
overall dims ¹ [mm]	A width	650	810	1020	1250
	B height	1160	1600	1840	2000
	C depth	960	1000	1000	1100
internal dims[mm]	D width	460	600	800	1040
	E height	540	800	1040	1200
	F depth	450	510	510	600
max shelf workload ² [kg]	-	10	10	10	-
	PW ³ version	50	100	100	100
max unit workload [kg]		60	90	120	140
nominal power [W]		See rating plate			
Total maximum power of electrical outlets (optional)		$\Sigma_{max.} 200 [W]$			
weight [kg]		103	140	185	275
over temperature protection		klasy 3.3			
power supply		400 [V] ±10% / 50 [Hz] 3P+N+PE			
shelves fitted/max		2/7	3/10	3/14	5/16
warranty		24 months			
manufacturer		POL-EKO-APARATURA			

1. external dimensions for units without FIT option, depth does not include 50mm of power cable
2. on uniformly loaded surface,
3. reinforced shelf.

All the above technical data refer to standard units (without optional accessories)

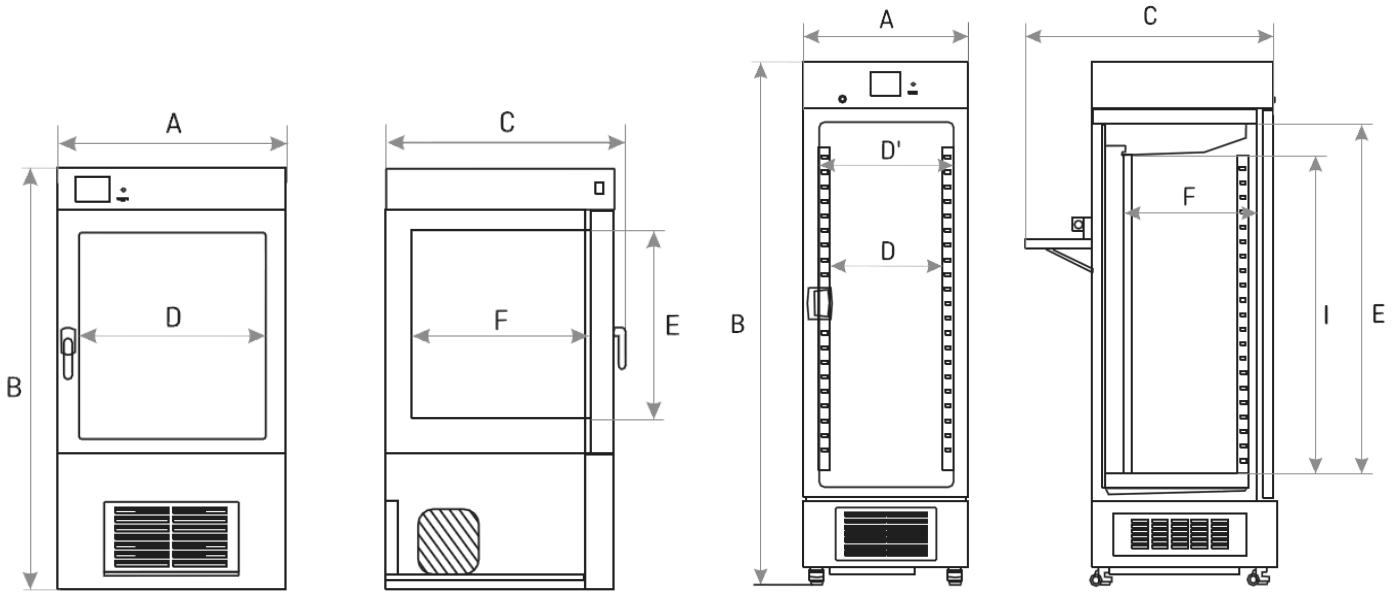

KK KKS: 115, 240, 400, 750

KK: 350

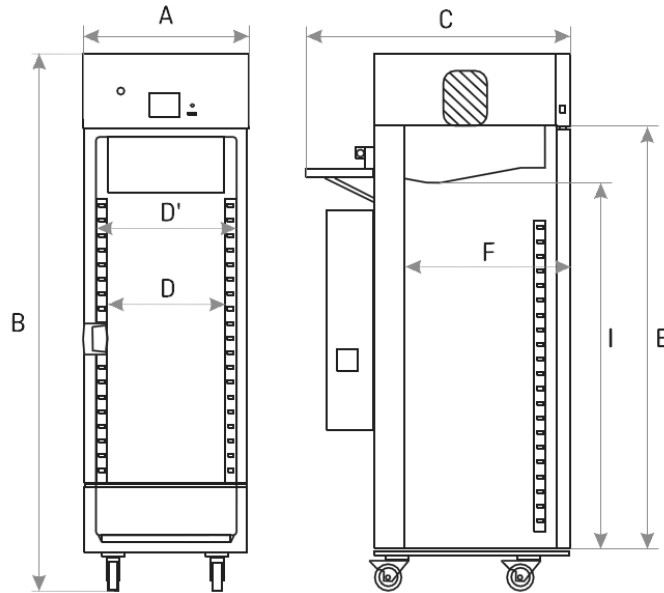

KK: 500, 700, 1200, 1450

ST, CHL

Parametr		ST1 CHL1	ST2 CHL2	ST3 CHL3	ST4 CHL4	ST5 CHL5	ST6 CHL6	ST500 CHL500	ST700 CHL700	ST1200 CHL1200	ST1450 CHL1450	
air convection		forced										
chamber capacity[l]	[l]	70	150	200	250	300	400	500	625	1365	1460	
working capacity[l]	[l]	55	122	163	203	243	324	386	450	1229	1307	
door type		solid / glass of double ¹ (option)										
temperature range[°C]	CHL	[°C]	0...+15				0...+15 / -10...+15 (option)					
		[°F]	32...+59				32...+59/14...+59 (option)					
	ST	[°C]	+3...+40/ do +70(option)/+3...+70 in PREM TOP+									
		[°F]	+37...+104 / do +158 (option)/ +37...+158 in PRM TOP+									
temperature resolution[°C]		every 0,1										
controller		microprocessor with external LCD graphic display										
interior	BASIC		aluminium									
	COMF		stainless steel to. DIN 1.4016									
	COMF/S		stainless steel to. DIN 1.4016									
	PREM (TOP+)		stal stainless steel to. DIN 1.4016DIN 1.4301									
	PREM/S (TOP+)		stainless steel to DIN 1.4016DIN 1.4301									
housing	BASIC		powder coated sheet									
	COMF		powder coated sheet									
	COMF/S		polished stainless steel									
	PREM (TOP+)		powder coated sheet									
	PREM/S (TOP+)		polished stainless steel									
overall dims ² [mm]	A width		570	620	620	620	620	620	660	750	1480	1450
	B height		600	860	1060	1260	1460	1860	1990	1990	1990	1970
	C depth		680	650	650	650	650	650	810	860	860	950
internal dims[mm]	D width		430	480	480	480	480	480	480	480	2x480	2x480
	D' width		470	520	520	520	520	520	510	600	1310	1340
	E height		430	660	860	1060	1260	1660	1510	1510	1510	1460
	F depth		300	420	420	420	420	420	650	690	690	750
	F' depth		360	480	480	480	480	480	-	-	-	-
	G depth		-	320	320	320	320	320	-	-	-	-
	H height		-	440	640	840	1050	1440	-	-	-	-
max shelf workload ² [kg]	-		10	10	10	10	10	10	20	30	30	30
	PW ⁵ version		On request						100	150	300	300
max unit workload [kg]	-		20	30	40	50	60	60	100	150	300	300
	W ⁶ version		On request									
Nominal Power [W]		See rating plate										
Total maximum power of electrical outlets (optional)		$\Sigma_{max.} 200 [W]$										
weight ⁸ [kg]		32	54	59	69	75	90	105	115	185	200	
over temperature protection		class 3.2 to DIN 12880 (CHL) class 3.3 to DIN 12880 (ST)										
power supply*		230 [V] ±10% / 50 [Hz]										
shelvesfitted/max		2/2	3/4	3/4	4/6	4/7	4/10	3/11	3/11	2x3/11 ⁹	2x3/11 ⁹	
cooling agent		R134a										
warranty		24 months										
manufacturer		POL-KO APARATURA										

Parametr			CHL1/1	CHL1/1/1	CHL2/2	CHL2/3	CHL2/4	CHL3/3
air convection			forced					
chamber capacity[l]			70/70	70/70/70	150/150	150/200	150/250	200/200
working capacity[l]			55/55	55/55/55	122/122	122/163	123/203	163/163
door type			solid / glass of double ¹ (option)					
temperaturerange[°C]	CHL	[°C]	0...+15					
		[°F]	32...+59					
	ST	[°C]	+3...+40/ do + 70(option) /+3...+70 w PREM TOP+					
		[°F]	+37...+104 / do +158 (option) / +37...+158 w PRM TOP+					
temperature resolution[°C]			every 0,1					
controller			microprocessor with external LCD graphic display					
interior	BASIC		aluminium					
	COMF		stainless steel to. DIN 1.4016					
	COMF/S		stainless steel to. DIN 1.4016					
	PREM (TOP+)		stal stainless steel to. DIN 1.4016DIN 1.4301					
	PREM/S (TOP+)		stainless steel to DIN 1.4016DIN 1.4301					
housing	BASIC		powder coated sheet					
	COMF		powder coated sheet					
	COMF/S		polished stainless steel					
	PREM (TOP+)		powder coated sheet					
	PREM/S (TOP+)		polished stainless steel					
overall dims ² [mm]	A width		570	570	620	620	620	620
	B height		1170	1740	1680	1880	2080	2080
	C depth		680	680	650	650	650	650
internal dims ³ [mm]	D width		430	480	480	480	480	480
	D' width		470	520	520	520	520	520
	E height		430	430	660	660/860	660/1060	860
	F depth		300	420	420	420	420	420
	F' depth		360	480	480	480	480	480
	G depth		-	320	320	320	320	320
	H height		-	440	640	840	1050	1440
max shelf workload ⁴ [kg]	-		10	10	10	10	10	10
	PW ⁵ version		On request					
max unit workload [kg]	-		20	30	40	50	60	60
	W ⁶ version		On request					
nominalpower ⁷ [W]			See rating plate					
weight [kg]			65	98	109	114	124	119
over temperature protection			class 3.2 to DIN 12880 (CHL) class 3.3 to DIN 12880 (ST)					
powe r supply			230 [V] ±10% / 50 [Hz]					
shelves fitted/max			See table for single chamber models					
Total maximum power of electrical outlets (optional)			Σ _{max} 200W					
cooling agent			R134a					
warranty			24 months					
manufacturer			POL-EKO APARATURA sp.j.					

1. additional internal glass door
2. depth does not include 50mm of power cable
3. dims of units with double door can be smaller
4. on uniformly loaded surface
5. reinforced shelf,
6. reinforced version,
7. for units in BASIC version solid door

All the above technical data refer to standard units (without optional accessories)

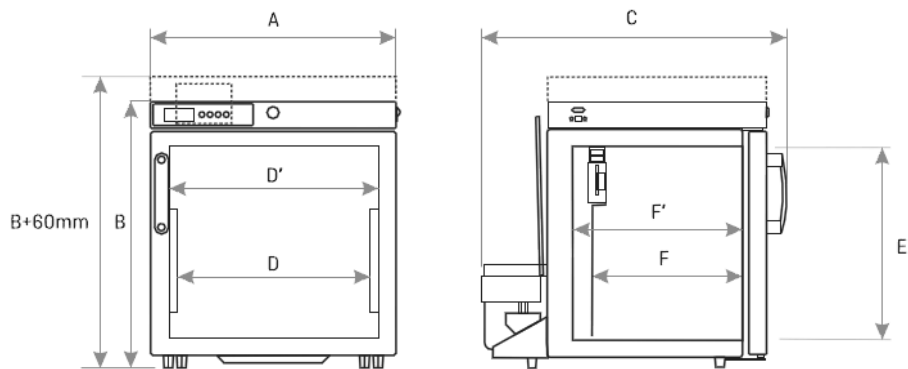

ST CHL: 1

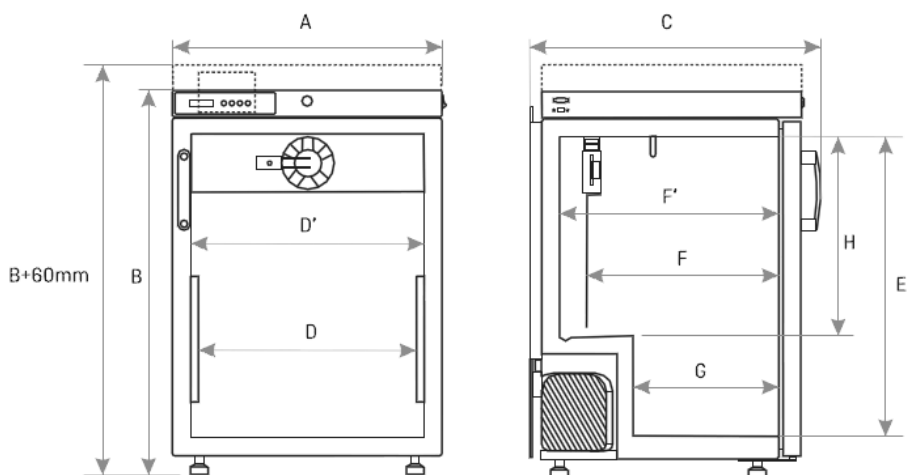

ST CHL: 2,3,4,5,6

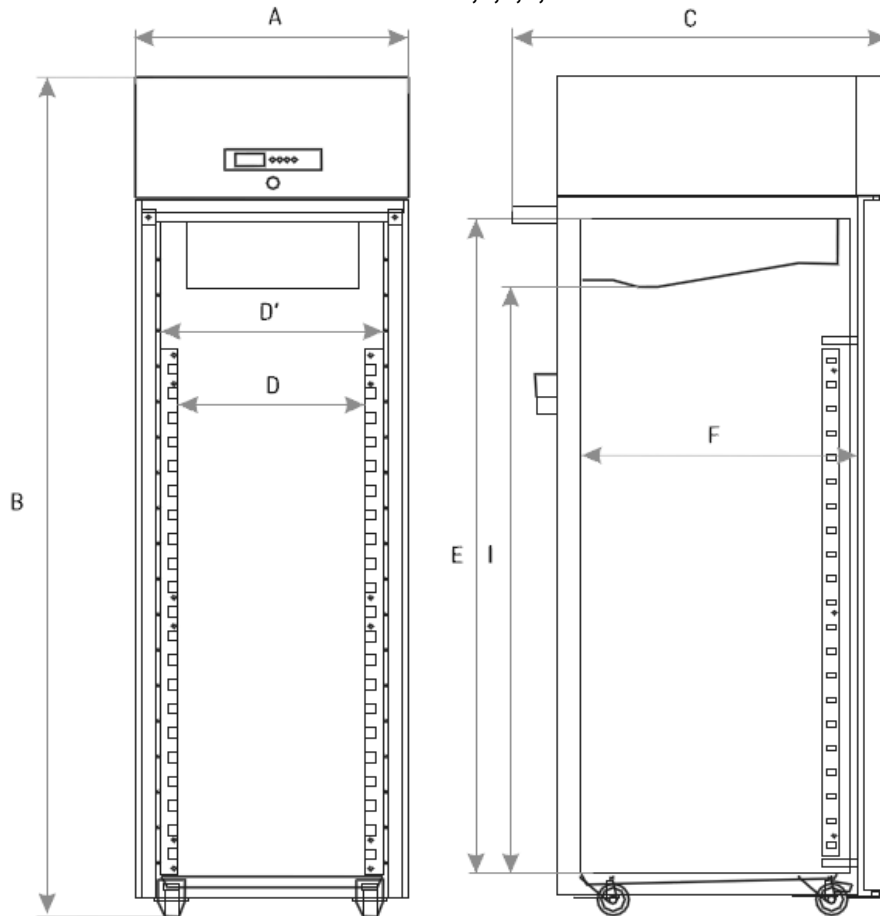

ST CHL 500, 700, 1200, 1450

SRWP

Parametr		SRWP115	SRWP240
air convection		forced	
chamber capacity ¹ [l]		112	245
door type		Solid/door with viewing windows (option)	
temperature range		+5 ⁰ C above ambient temperature ... +250 ⁰ C	
		+41 ⁰ F above ambient temperature ... 482 ⁰ F	
temperature resolution ⁰ [C]		every 0,1	
controller		microprocessor with external LCD graphic display	
interior		acid- proof stainless stell to DIN 1.4301	
housing	-	powder coated sheet	
	INOX/G	stainless stell linen finish	
overall dims ² [mm]	width	680	820
	height	960	1160
	depth	700	770
internal dims [mm]	width	460	600
	height	530	800
	depth	460	510
max shelf workload ⁵ [kg]	-	10	
	PW ³ version	50	100
max unit workload [kg]	-	60	90
	W ⁴ version	120	300
nomina lpower[W]		See rating plate	
weight [kg]		65	126
over temperature protection		class 2.0 according to DIN 12880/class 3.1(option)/3.1 in TOP+	
Power supply		230 [V] ±10% / 50 [Hz]	
shelvesfitted/max		2/7	3/10
warranty		24 months	
manufacturer		POL – EKO APARATURA	

1. working capacity of chamber can be smaller,
2. depth does not include 50mm of power cable
3. reinforced shelf,
4. reinforced version,
5. on uniformly loaded surface

17 WORKING SPACE WITH HUMIDITY

17.1 Without light

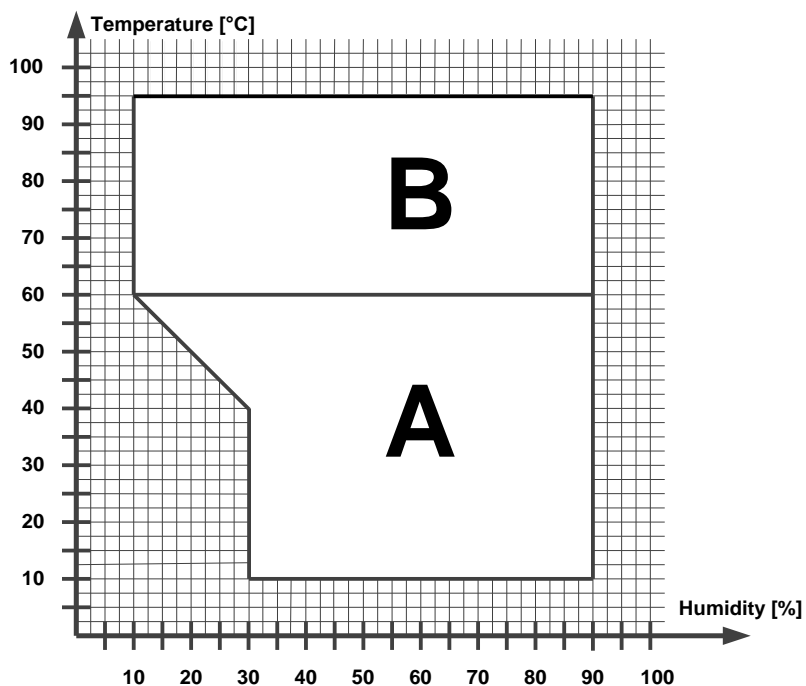

A – range available for climatic chamber with ultrasonic humidifier (KK).

A and B – range available for climatic chamber with steam humidifier (KKS).

17.2 Devices in FIT version

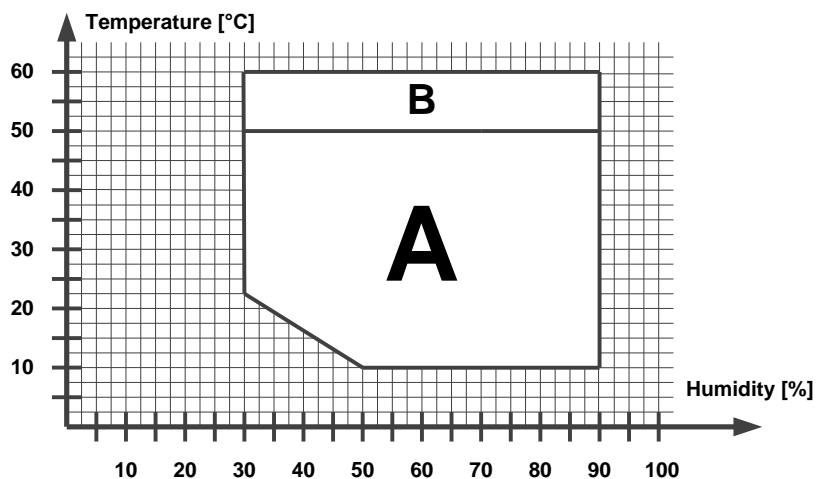

A – available for work with lights switched on and off,

B – available for work with lights off only.

18 MAINTENANCE AND INSPECTION REGISTER

Type of the unit:..... Serial no:

18.1 Maintenance for ILW, CHL, ST, KKS or KK

No.	Date	Compressor and evaporator cleaning	Signature
1			
2			
3			
4			
5			
6			
7			
8			
9			
10			
11			
12			
13			
14			
15			
16			
17			
18			
19			
20			
21			
22			
23			
24			

* every month; every week in case of high dust occurrence

18.2 Inspection

Technical inspection performed by POL-EKO-APARATURA's service once a year:

No.	Date	Description	Performer	Signature
1				
2				
3				
4				
5				



DEKLARACJA ZGODNOŚCI UE

EU DECLARATION OF CONFORMITY



Produkt:	Product:
Suszarka laboratoryjna	Drying oven
Model:	Model:
SLW 15; SLW 32; SLW 53; SLW 75; SLW 115; SLW 180; SLW 240; SLW 400; SLW 750; SLW 1000 SLN 15; SLN 32; SLN 53; SLN 75; SLN 115; SLN 180; SLN 240	
w wersjach:	in version:
STD, STD INOX/G, TOP+, TOP+ INOX/G	
Nazwa i adres producenta:	Name and address of the manufacturer:
POL-EKO-APARATURA sp.j. A. Polok-Kowalska, S. Kowalski ul. Kokoszycka 172c 44-300 Wodzisław Śl.	
Niniejsza deklaracja zgodności wydana zostaje na wyłączną odpowiedzialność producenta.	This declaration of conformity is issued under the sole responsibility of the manufacturer.
Wymieniony powyżej przedmiot niniejszej deklaracji jest zgodny z odnośnymi wymaganiami unijnego prawodawstwa harmonizacyjnego:	The object of the declaration described above is in conformity with the relevant Union harmonisation legislation:
LVD 2014/35/UE EMC 2014/30/UE RoHS 2011/65/UE WEEE 2012/19/UE	LVD 2014/35/EU EMC 2014/30/EU RoHS 2011/65/EU WEEE 2012/19/EU
Odniesienia do odnośnych norm zharmonizowanych, które zastosowano, lub do innych specyfikacji technicznych, w stosunku, do których deklarowana jest zgodność:	References to the relevant harmonised standards used or references to the other technical specifications in relation to which conformity is declared:
LVD	PN-EN 61010-1:2011 PN-EN 61010-2-010:2015-01 PN-EN 60519-1:2015-10 PN-EN 60529:2003/A2:2014-07
EMC	PN-EN 61326-1:2013-06
RoHS	PN-EN 50581:2013-03

Wodzisław Śl. 26.07.2017

POL-EKO-APARATURA sp.j.
DYREKTOR
Sebastian Kowalski
(Director)



DEKLARACJA ZGODNOŚCI UE

EU DECLARATION OF CONFORMITY



Produkt: Cieplarka laboratoryjna	Product: Laboratory incubator
Model: CLW 15; CLW 32; CLW 53; CLW 75; CLW 115; CLW 180; CLW 240; CLW 400; CLW 750; CLW 1000 CLN 15; CLN 32; CLN 53; CLN 75; CLN 115; CLN 180; CLN 240	Model:
w wersjach: STD, STD INOX/G, TOP+, TOP+ INOX/G	in version:
Nazwa i adres producenta: POL-EKO-APARATURA sp.j. A. Polok-Kowalska, S. Kowalski ul. Kokoszycka 172c 44-300 Wodzisław Śl.	Name and address of the manufacturer:
Niniejsza deklaracja zgodności wydana zostaje na wyłączną odpowiedzialność producenta.	This declaration of conformity is issued under the sole responsibility of the manufacturer.
Wymieniony powyżej przedmiot niniejszej deklaracji jest zgodny z odnośnymi wymaganiami unijnego prawodawstwa harmonizacyjnego: LVD 2014/35/UE EMC 2014/30/UE RoHS 2011/65/UE WEEE 2012/19/UE	The object of the declaration described above is in conformity with the relevant Union harmonisation legislation: LVD 2014/35/UE EMC 2014/30/UE RoHS 2011/65/UE WEEE 2012/19/UE
Odniesienia do odnośnych norm zharmonizowanych, które zastosowano, lub do innych specyfikacji technicznych, w stosunku, do których deklarowana jest zgodność: LVD EMC RoHS	References to the relevant harmonised standards used or references to the other technical specifications in relation to which conformity is declared: PN-EN 61010-1:2011 PN-EN 61010-2-010:2015-01 PN-EN 60519-1:2015-10 PN-EN 60529:2003/A2:2014-07 PN-EN 61326-1:2013-06 PN-EN 50581:2013-03

Wodzisław Śl. 26.07.2017

POL-EKO-APARATURA sp.j.
DYREKTOR
Sebastian Kowalski
(Director)



DEKLARACJA ZGODNOŚCI UE

EU DECLARATION OF CONFORMITY



Produkt:	Product:
Inkubator z chłodzeniem	Cooled incubator
Model:	Model:
ILW 53; ILW 115; ILW 240; ILW 400; ILW 750	
w wersjach:	in version:
STD, STD INOX/G, TOP+, TOP+ INOX/G Z opcją (with option) FOT, FIT	
Nazwa i adres producenta:	Name and address of the manufacturer:
POL-EKO-APARATURA sp.j. A. Polok-Kowalska, S. Kowalski ul. Kokoszycka 172c 44-300 Wodzisław Śl.	
Niniejsza deklaracja zgodności wydana zostaje na wyłączną odpowiedzialność producenta.	This declaration of conformity is issued under the sole responsibility of the manufacturer.
Wymieniony powyżej przedmiot niniejszej deklaracji jest zgodny z odnośnymi wymaganiami unijnego prawodawstwa harmonizacyjnego:	The object of the declaration described above is in conformity with the relevant Union harmonisation legislation:
LVD 2014/35/UE EMC 2014/30/UE RoHS 2011/65/UE WEEE 2012/19/UE	LVD 2014/35/EU EMC 2014/30/EU RoHS 2011/65/EU WEEE 2012/19/EU
Odniesienia do odnośnych norm zharmonizowanych, które zastosowano, lub do innych specyfikacji technicznych, w stosunku, do których deklarowana jest zgodność:	References to the relevant harmonised standards used or references to the other technical specifications in relation to which conformity is declared:
LVD	PN-EN 61010-1:2011 PN-EN 61010-2-010:2015-01 PN-EN 60519-1:2015-10 PN-EN 60529:2003/A2:2014-07
EMC	PN-EN 61326-1:2013-06
RoHS	PN-EN 50581:2013-03

Wodzisław Śl. 23.05.2017

POL-EKO-APARATURA sp.j.
DYREKTOR
Sebastian Kowalski
(Director)



DEKLARACJA ZGODNOŚCI UE

EU DECLARATION OF CONFORMITY



Produkt: Komora klimatyczna	Product: Climatic chamber
Model: KK 115; KK 240; KK 350; KK 400; KK 500; KK 700; KK 750; KK 1200; KK 1450; KKS 115; KKS 240; KKS 400; KKS 750	Model:
w wersjach: Z opcją (with option) FIT, FOT	in version: TOP+, TOP+ INOX/G
Nazwa i adres producenta:	Name and address of the manufacturer:
POL-EKO-APARATURA sp.j. A. Polok-Kowalska, S. Kowalski ul. Kokoszycka 172c 44-300 Wodzisław Śl.	
Niniejsza deklaracja zgodności wydana zostaje na wyłączną odpowiedzialność producenta.	This declaration of conformity is issued under the sole responsibility of the manufacturer.
Wymieniony powyżej przedmiot niniejszej deklaracji jest zgodny z odnośnymi wymaganiami unijnego prawodawstwa harmonizacyjnego:	The object of the declaration described above is in conformity with the relevant Union harmonisation legislation:
LVD 2014/35/UE EMC 2014/30/UE RoHS 2011/65/UE WEEE 2012/19/UE PED 2014/68/UE	LVD 2014/35/EU EMC 2014/30/EU RoHS 2011/65/EU WEEE 2012/19/EU PED 2014/68/EU
Odniesienia do odnośnych norm zharmonizowanych, które zastosowano, lub do innych specyfikacji technicznych, w stosunku, do których deklarowana jest zgodność:	References to the relevant harmonised standards used or references to the other technical specifications in relation to which conformity is declared:
LVD	PN-EN 61010-1:2011 PN-EN 61010-2-010:2015-01 PN-EN 60519-1:2015-10 PN-EN 60529:2003/A2:2014-07
EMC	PN-EN 61326-1:2013-06
RoHS	PN-EN 50581:2013-03

Wodzisław Śl. 23.05.2017

POL-EKO-APARATURA sp.j.
DYREKTOR
Sebastian Kowalski
(Director)



DEKLARACJA ZGODNOŚCI UE

EU DECLARATION OF CONFORMITY



Produkt: Szafa termostatyczna	Product: Cooled incubator (ST)
Model: ST 1, ST 2, ST 3, ST 4, ST 5, ST 6, ST 500, ST 700, ST 1200, ST 1450, ST 1/1, ST 1/1/1, ST 2/2, ST 2/3, ST 2/4, ST 3/3	Model:
w wersjach: BASIC; COMF; COMF/S; PREM; PREM/S; PREM TOP+; PREM/S TOP+ *z opcją (with option) FOT, FIT	in version:
Nazwa i adres producenta: POL-EKO-APARATURA sp.j. A. Polok-Kowalska, S. Kowalski ul. Kokoszycka 172c 44-300 Wodzisław Śl.	Name and address of the manufacturer:
Niniejsza deklaracja zgodności wydana zostaje na wyłączną odpowiedzialność producenta.	This declaration of conformity is issued under the sole responsibility of the manufacturer.
Wymieniony powyżej przedmiot niniejszej deklaracji jest zgodny z odnośnymi wymaganiami unijnego prawodawstwa harmonizacyjnego: LVD 2014/35/UE EMC 2014/30/UE RoHS 2011/65/UE WEEE 2012/19/UE	The object of the declaration described above is in conformity with the relevant Union harmonisation legislation: LVD 2014/35/EU EMC 2014/30/EU RoHS 2011/65/EU WEEE 2012/19/EU
Odniesienia do odnośnych norm zharmonizowanych, które zastosowano, lub do innych specyfikacji technicznych, w stosunku, do których deklarowana jest zgodność: LVD EMC RoHS	References to the relevant harmonised standards used or references to the other technical specifications in relation to which conformity is declared: PN-EN 61010-1:2011 PN-EN 61010-2-010:2015-01 PN-EN 60519-1:2015-10 PN-EN 60529:2003/A2:2014-07 PN-EN 61326-1:2013-06 PN-EN 50581:2013-03

Wodzisław Śl. 23.05.2017

POL-EKO-APARATURA sp.j.
DYREKTOR
Sebastian Kowalski
(Director)



DEKLARACJA ZGODNOŚCI UE

EU DECLARATION OF CONFORMITY



Produkt: Chłodziarka laboratoryjna	Product: Laboratory refrigerators
Model: CHL 1; CHL 2; CHL 3; CHL 4; CHL 5; CHL 6; CHL 500; CHL 700; CHL 1200; CHL 1450; CHL 1/1; CHL 1/1/1; CHL 2/2; CHL 2/3; CHL 2/4; CHL 3/3	Model:
w wersjach: BASIC, COMF, COMF/S, PREM, PREM/S, PREM TOP+, PREM/S TOP+	in version:
Nazwa i adres producenta: POL-EKO-APARATURA sp.j. A. Polok-Kowalska, S. Kowalski ul. Kokoszycka 172c 44-300 Wodzisław Śl.	Name and address of the manufacturer:
Niniejsza deklaracja zgodności wydana zostaje na wyłączną odpowiedzialność producenta.	This declaration of conformity is issued under the sole responsibility of the manufacturer.
Wymieniony powyżej przedmiot niniejszej deklaracji jest zgodny z odnośnymi wymaganiami unijnego prawodawstwa harmonizacyjnego: LVD 2014/35/UE EMC 2014/30/UE RoHS 2011/65/UE WEEE 2012/19/UE	The object of the declaration described above is in conformity with the relevant Union harmonisation legislation: LVD 2014/35/UE EMC 2014/30/UE RoHS 2011/65/UE WEEE 2012/19/UE
Odniesienia do odnośnych norm zharmonizowanych, które zastosowano, lub do innych specyfikacji technicznych, w stosunku, do których deklarowana jest zgodność: LVD EMC RoHS	References to the relevant harmonised standards used or references to the other technical specifications in relation to which conformity is declared: PN-EN 61010-1:2011 PN-EN 61010-2-010:2015-01 PN-EN 60519-1:2015-10 PN-EN 60529:2003/A2:2014-07 PN-EN 61326-1:2013-06 PN-EN 50581:2013-03

Wodzisław Śl. 23.05.2017

POL-EKO-APARATURA sp.j.
DYREKTOR
Sebastian Kowalski
(Director)



DEKLARACJA ZGODNOŚCI UE
EU DECLARATION OF CONFORMITY



Produkt:	Product:
Sterylizator przelotowy	Pass-through sterilizer
Model:	Model:
SRWP 115; SRWP 240;	
w wersjach:	in version:
STD, STD INOX/G, TOP+, TOP+ INOX/G	
Nazwa i adres producenta:	Name and address of the manufacturer:
POL-EKO-APARATURA sp.j. A. Polok-Kowalska, S. Kowalski ul. Kokoszycka 172c 44-300 Wodzisław Śl.	
Niniejsza deklaracja zgodności wydana zostaje na wyłączną odpowiedzialność producenta.	This declaration of conformity is issued under the sole responsibility of the manufacturer.
Wymieniony powyżej przedmiot niniejszej deklaracji jest zgodny z odnośnymi wymaganiami unijnego prawodawstwa harmonizacyjnego:	The object of the declaration described above is in conformity with the relevant Union harmonisation legislation:
LVD 2014/35/UE EMC 2014/30/UE RoHS 2011/65/UE WEEE 2012/19/UE	LVD 2014/35/EU EMC 2014/30/EU RoHS 2011/65/EU WEEE 2012/19/EU
Odniesienia do odnośnych norm zharmonizowanych, które zastosowano, lub do innych specyfikacji technicznych, w stosunku, do których deklarowana jest zgodność:	References to the relevant harmonised standards used or references to the other technical specifications in relation to which conformity is declared:
LVD	PN-EN 61010-1:2011 PN-EN 61010-2-010:2015-01 PN-EN 60519-1:2015-10 PN-EN 60529:2003/A2:2014-07
EMC	PN-EN 61326-1:2013-06
RoHS	PN-EN 50581:2013-03

Wodzisław Śl. 23.05.2017

POL-EKO-APARATURA sp.j.
DYREKTOR
Sebastian Kowalski
(Director)



**Producer of basic and indispensable laboratory equipment
as well as continuous measurement equipment.**

**Authorized dealer of:
Knick, Thermo Scientific, WTW**



POL-EKO-APARATURA sp.j.

**A. Polok-Kowalska, S. Kowalski
ul. Kokoszycka 172 C
44-300 Wodzislaw Slaski, Poland
Tel. +48 / 32 453 91 70, Fax. +48 / 32 453 91 85**

e-mail: info@pol-eko.com.pl

web: <https://www.pol-eko.com.pl> * <https://www.cieplarki.pl>

We produce:

- thermostatic cabinets
- refrigerators
- laboratory freezers
- heating ovens
- cooled incubators
- drying ovens
- colony counters
- stationary samplers
- specialized devices for controlled sewage and waste waters taking

We organize:

- trainings
- seminars

We provide:

- warranty service
- post-warranty service

We offer portable, laboratory and on-line equipment:

- pH-meters
- ISE measuring
- dissolved oxygen meters
- conductivity meters
- photometers
- spectrophotometers
- thermo reactors
- turbidity meters
- heavy metals trace analyzers
- pH electrodes
- conductivity sensors
- D.O. sensors
- pH buffer solutions
- conductivity standards
- photometric tests
- chromatography syringes
- laboratory accessories

**We advise our customers as far as the choice
and maintenance of the equipment are concerned !**